



LEADING SWISS PRODUCTS



ProofMaster CP[®]

Operating instructions

Characteristic data

Document

Type: Operating instructions

Language: English

Change log

Version	Date	Author	Description
Version 1.0	06.05.2022	RdT – MAG	First edition.

Info



The original text of these instructions is written in German.

Translations are made for information purposes only. In cases of doubt, only the German version shall be decisive.

Manufacturer

Witschi Electronic AG

Bahnhofstrasse 26

3294 Büren an der Aare

Switzerland

Product

ProofMaster CP

Copyright

Reproduction of this document in whole or in part is not permitted. Without the prior written consent of Witschi Electronic AG, no section may be copied, edited or electronically reproduced, transmitted or recorded on magnetic media or in any other way.

All rights, in particular those of reproduction, distribution and translation into other languages, as well as those of patent law and patent application are reserved. The same copyright also applies to the software supplied with the devices from Witschi Electronic AG.

© Copyright Witschi Electronic AG, 2022 – all rights reserved.

Table of contents

1	General information.....	6
1.1	Technical support.....	7
1.2	Definitions.....	7
1.3	Guarantee.....	8
2	Safety.....	9
2.1	General pictograms.....	9
2.2	Proper use.....	10
2.3	Safety sign.....	11
2.3.1	Labels on the device.....	11
2.3.2	Labels on the power supply unit.....	11
2.4	Residual risks.....	11
2.5	Owner's liability.....	14
2.6	Personnel qualifications.....	15
2.7	Personal protective equipment.....	16
2.8	Spare parts.....	16
2.9	Noise emissions.....	16
3	Initial operation.....	17
3.1	Moving the device.....	17
3.2	Transport inspection.....	18
3.3	Storage conditions.....	18
3.4	Space requirement.....	19
3.5	Requirements regarding the installation site.....	19
3.6	Working area of the operator.....	20
3.7	List of equipment.....	21
3.8	Initial operation.....	22
3.8.1	Current.....	22
3.8.2	Compressed air.....	22
3.8.3	Thermal printer.....	23
3.8.4	Network.....	24
4	Description.....	25
4.1	ProofMaster CP.....	25
4.2	Included accessories.....	26
4.3	Optional accessories.....	28
4.4	Procedure of a tightness test.....	29

4.5	Definitions.....	30
4.6	Reference to standard ISO 22810	31
5	Use	32
5.1	Safety during use	32
5.2	Basic operation	32
5.2.1	Switch on the ProofMaster CP.....	32
5.2.2	Enabling screen saver or standby	32
5.2.3	Switching off the device.....	34
5.2.4	Determining test pressure values.....	34
5.2.5	Selecting the program (ProofMaster CP)	36
5.2.6	Starting the test	37
5.2.7	Cancelling the test.....	37
5.2.8	Positioning the watch	38
5.2.9	Manually lowering/lifting the sensor	39
5.2.10	Identifying the tests	40
5.3	Measurement results	41
5.3.1	Displaying test results	41
5.3.2	Selecting the results display	43
5.4	Programming.....	44
5.4.1	Menus and operating buttons.....	44
5.4.2	Preset programs	45
5.5	ChronoMaster Air	47
5.5.1	Connecting the ChronoMaster Air	47
5.5.2	Starting the measurement	47
5.5.3	Configuring the measurement	48
6	Maintenance	50
6.1	Safety during maintenance	50
6.2	Maintenance schedule.....	51
6.3	Cleaning the seal (O ring).....	52
6.4	Replacing the seal (O ring).....	52
6.5	Replacing the deformation sensor	52
6.6	Accessories and spare parts	53
7	Settings.....	54
7.1	Quick settings menu.....	54
7.2	Settings.....	55
7.3	System	56
7.3.1	Language selection.....	56
7.3.2	Screen saver.....	57
7.3.3	Display and audio settings	59
7.3.4	Date & time.....	60
7.3.5	Software update.....	61

7.4	Device.....	63
7.4.1	Opening speed of the bell cover.....	63
7.4.2	Start by pressing the bell cover.....	63
7.4.3	Sensor lighting.....	64
7.4.4	Quiet pressure release.....	64
7.4.5	Unit of leak rate.....	65
7.5	Import/export.....	66
7.5.1	Importing/exporting settings.....	66
7.5.2	Exporting measurements.....	68
7.5.3	Resetting the device settings.....	69
7.5.4	Restoring factory settings.....	70
7.6	Printer.....	71
7.6.1	Configuring the printer.....	71
7.6.2	Configuring the label.....	72
7.7	Network.....	75
7.8	WiCoTRACE.....	76
7.9	ChronoMaster Air (establishing a connection for Bluetooth).....	78
7.10	System information.....	79
8	Troubleshooting.....	80
8.1	Error messages.....	80
8.2	Malfunctions.....	81
8.3	Opening the bell cover in an emergency.....	82
9	Decommissioning and disposal.....	83
10	Data sheet.....	84

1 General information

Purpose of the documentation

This documentation contains the necessary information for the proper operation of the device.

This allows the user to perform operating or maintenance procedures efficiently.

For reasons of safety and environmental protection, the service instructions must be followed. In any case, the documentation should be consulted.

Liability

Witschi Electronic AG assumes no liability for errors or omissions.

Conformity with standards and guidelines

The "CE" marking confirms that this product complies with the European requirements regarding safety, health, environmental and user protection.



See also the declaration of conformity supplied with the machine.

Proper use

The instructions in this document must be observed, in particular the safety precautions.

General information

This document has been prepared on the basis of the information available at the time of its publication.

These instructions enable safe and efficient handling of the ProofMaster CP leak tightness testing device (referred to in the following as "device" or "ProofMaster CP"). These instructions are an integral part of the device and must be kept near the device so that it can be accessed by personnel at all times.

Personnel must have carefully read through and understood these instructions before starting work. To ensure safe working, the safety indications, warnings and instructions must be followed.

In addition, the local health and safety regulations as well as the general safety rules for operation of the ProofMaster CP must be observed.

Illustrations contained in these instructions are intended for illustration purposes only and may deviate from the model sold.

1.1 Technical support

Rating plate



The rating plate of the ProofMaster CP is located on the reverse of the device and contains the following information:

- Manufacturer
- Device name
- Type
- Serial number
- Year of manufacture

Technical support inquiries

To request technical support from Witschi Electronic AG, proceed as follows:

- a) Observe the specifications on the machine's rating plate.
- b) Try to clearly identify the error that occurred.
- c) Contact the customer service of Witschi Electronic AG.

Customer service

The point of sale can provide you with technical information.

The nearest point of sale can be found on the Witschi Electronic AG website www.witschi.com.

Witschi Electronic AG would also be pleased to receive information and feedback, which can be helpful for the improvement of the products.

Information on customer service

Address: Witschi Electronic AG
 Bahnhofstrasse 26
 3294 Büren an der Aare
 Switzerland

Telephone: +41 32 352 05 00

Fax: +41 32 351 32 92

Internet: www.witschi.com

E-mail: service@witschi.com

1.2 Definitions

User

The user is the owner of a device which he or she uses as the owner or which he or she gives to third parties for use.

Operator

The operator is the person who carries out production or operating processes with the device.

Technical personnel

Technical personnel are defined as all persons whose training and qualifications entitle them to carry out installation and maintenance work on the device. Any work on the electrical and mechanical components of the device must be carried out by Witschi Electronic AG.

Device

A device is defined as the entirety of the ProofMaster CP.

1.3 Guarantee

Witschi Electronic AG grants two years warranty on the new ProofMaster CP. Further information can be found in the **Warranty information document** supplied with the ProofMaster CP.

2 Safety

This section provides an overview of all the important safety aspects that ensure personal protection and safe and trouble-free operation. The relevant sections contain additional warnings on the various tasks.

Mandatory



All safety and protection regulations described here must be read and observed in order to avoid damage to equipment, persons and the environment.

The legal regulations, accident prevention and environmental protection measures as well as the relevant technical regulations for safe working methods in the country of use and at the place of installation of the device must also be observed.

2.1 General pictograms

DANGER



This combination of symbol and keyword indicates an imminently hazardous situation that will result in serious or fatal injury if not avoided.

WARNING



This combination of symbol and keyword indicates a potentially hazardous situation that can result in serious or fatal injury if not avoided.

CAUTION



This combination of symbol and keyword indicates a potentially hazardous situation that can result in minimal or minor injury if not avoided.

Caution - material



This combination of symbol and keyword indicates a potentially hazardous situation that can entail material damage if not avoided.

Caution - environmental



This combination of symbol and keyword indicates a potentially hazardous situation that can entail environmental damage if not avoided.

Prohibition



Mandatory advice to follow.

Mandatory



Applicable guideline, measure.

Info



Informative comment.

Tip



Recommendation or advice.

2.2 Proper use

The "ProofMaster CP" leak tightness testing device is used exclusively for testing the water resistance of watches by means of positive and negative pressure.

The ProofMaster CP can be used to check the water resistance of both digital watches and analogue or pocket watches in accordance with the watch manufacturer's specifications.

You can also use the ProofMaster CP to build up positive pressure in the case of a leaky watch to then find the leak by testing it in water.

The device is intended for watches with the following maximum dimensions:

- Diameter: 70 mm
- Thickness: 30 mm
- Width: 85 mm

Proper use also includes observing all the information in the document. Any use that deviates from the proper use is considered improper use.

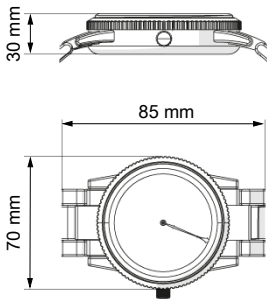

CAUTION



Risk of injury if the device is used improperly!

Improper use of the ProofMaster CP can result in hazardous situations.

2.3 Safety sign

The parts of the device which represent a danger are marked with a safety label.

Mandatory



Make sure that the safety labels on the device are clearly legible and clean!

If the labels become dirty or illegible over time, so that hazards can no longer be identified or service instructions can no longer be followed, they must be replaced with new ones and affixed to the same place.

2.3.1 Labels on the device

Calibration of the ProofMaster CP

The stickers listed below are affixed to the ProofMaster CP.

The sticker on the underside of the device shows when the device was last calibrated.



Info



The reliability of the measurement results is guaranteed by regular calibration of the ProofMaster CP.

2.3.2 Labels on the power supply unit

Electrical and electronic components

The labels below are affixed to the power supply unit.

The electrical and electronic components in the device contain toxic substances. The device must therefore be disposed of in a recycling depot or by a specialised company.



CE conformity



The "CE" marking confirms that this product complies with the European requirements regarding safety, health, environmental and user protection.

2.4 Residual risks

Cracked glass

CAUTION



Risk of injury from cracked glass!

The positive pressure can penetrate into leaking watches during the test. If this is the case, the interior of the watches will be under pressure after the test. The glass in the watch can then splinter or crack. It can cause serious eye injuries and even blindness.

Mandatory



Observe the instructions for wearing safety goggles in this Operating instructions!

If it is necessary to wear safety glasses, make sure that other people in the room are at an appropriate distance from the device.

Moving parts

 **CAUTION**



Risk of injury from moving parts!

Moving parts inside the device can cause serious injuries including loss of limbs.

Prohibition



Never open the device housing manually!

The housing may close again, trapping an object or part of the body.

Mandatory



Return a defective device to the manufacturer immediately!

To avoid damage of any kind.

Risk of crushing

 **CAUTION**



Risk of crushing when closing the bell cover!

There is a risk of crushing between the bell cover and the housing of the device when closing the bell cover.

- Before closing the bell cover, make sure that no body parts or objects are inside the closing area.

Current

Caution - material



Material damage due to short circuit!

Damage to the insulation on the power cord or the power supply unit can result in a short circuit and damage the ProofMaster CP.

Prohibition



Never immerse the device in water!

It is not designed for immersion.

Mandatory



Follow the obligations set out below:

Work on electronic components of the ProofMaster CP must only be carried out by customer service!

Failure to do so could void the warranty.

Always disconnect the mains plug before cleaning, maintenance or repair work!

To avoid electric shock.

To disconnect the power supply unit from the power supply, only pull on the plug itself, never pull on the cable.

To avoid damage to the cable.

Observe the following recommendations to avoid short circuits:

- If the power cord or power supply unit is damaged, disconnect the mains plug and have the power supply unit repaired.
- Place the power cord so that it cannot be damaged by external influences.
- Ensure that access to the power supply is always guaranteed.
- Protect live parts from moisture.

Opening the housing

Caution - material



Material damage due to opening the housing!

When opening the housing, there is a risk that internal components of the device or the housing may be damaged.

Prohibition



Never open the housing yourself!

Opening the housing will void the warranty and Witschi Electronic AG will not be liable for any accident occurring after the housing has been opened by an unqualified person.

Mandatory



In the event of malfunctions or problems that cannot be solved with the help of these instructions, contact the manufacturer!

Failure to do so could void the warranty.

Test pressure

Caution - material



Material damage due to excessive test pressure!

Applying excessive test pressure can damage the watch being tested and/or the ProofMaster CP.

Prohibition



Do not exceed the maximum supply pressure of 12 bar!

Device components could otherwise burst.

Mandatory



Follow the obligations set out below:

Make sure that the watch can withstand the pressure!

To avoid damaging the watch.

Only check watches for which a maximum water depth is specified, without exceeding the limit value!

Observe the following rule: 10 m water depth = 1 bar test pressure.

Observe the test pressure values!

See section *Determining test pressure values* [Page 34].

Check watches without special information at a maximum pressure of 2 bar!

To avoid damaging the watch.

Water ingress

Caution - material



Damage to the watch being tested due to water ingress!

The watch will only remain sealed in the water as long as there is a positive pressure in the housing, and, if the leak in the watch is too large, there is a risk of water penetrating the interior of the watch during the water test.

Mandatory



Follow the obligations set out below:

Only perform the water test once the "Leak Finder" program has been executed and the watch can be submerged in water without any risk!

Perform the test in the water immediately after the "Leak Finder" program has ended!

The watch can only be safely immersed in water for as long as there is positive pressure in the housing.

Witschi Electronic AG accepts no liability for watches that are penetrated by water.

If the display is red, remove the watch from the water!

The positive pressure in the watch is too low and water can penetrate.

Touchscreen

Caution - material



Material damage due to operating the touchscreen with sharp objects!

The touchscreen can be damaged if it is operated with sharp objects (for example with ballpoint pens).

- Operate the touchscreen with the stylus provided for the purpose or with your fingers.

2.5 Owner's liability

The device is intended for commercial use. The user is therefore subject to the statutory obligations of occupational health and safety.

In addition to the safety instructions and warnings in these instructions, the applicable regulations regarding safety, occupational health and safety and environmental protection for the operation of the device must also be observed.

The following must be taken into account:

- The user must learn about the applicable occupational health and safety requirements and identify additional hazards as part of an assessment of the existing risks, depending on the specific working conditions at the device's site of operation. The user shall take account of this assessment to create operating instructions for the use of the device.
- Throughout the service life of the device, the user must ensure that the operating instructions which he or she has drawn up comply with current regulations and, if necessary, adapt them.
- The user must ensure that all persons who use the device have read and understood these instructions. In addition, the user must also ensure that personnel are regularly trained and informed of the hazards.
- The user must provide personnel with the required protective equipment and ensure that the required protective equipment is worn, see *Personal protective equipment* [▶ Page 16].
- The owner must ensure that the service intervals specified in the instructions are complied with.
- The owner must ensure that the service intervals for the components (especially the compressor) are complied with.

2.6 Personnel qualifications

CAUTION



Risk of injury in the event of inadequate personnel qualifications!

If unqualified personnel carry out work on the device or stay in the device's danger zone, there is a risk of injury and significant material damage.

Mandatory



Follow the obligations set out below:

All activities may only be carried out by qualified personnel!

To avoid operating errors.

The operator of the device must have the appropriate knowledge and have completed the necessary training for the correct handling of watches!

In addition, during training, the operator must be informed by the user of the tasks assigned to him or her and of possible hazards in the event of improper behaviour. The operator may only carry out tasks that go beyond the scope of use in normal operation where this is specified during training and the user has specifically entrusted the operator to do so.

Unauthorised persons must keep a safe distance from the device!

To avoid unnecessary dangers.

2.7 Personal protective equipment

Personal protective equipment is a device or means worn or held by a person to protect him or her from one or more risks which could threaten his or her safety or health.

Safety goggles



Safety goggles protect the eyes from flying splinters of glass.

Safety goggles must be worn for the following activities, in particular:

- When removing the watch after a completed test.
- When preparing and carrying out the water test.

Mandatory



Observe the instructions for wearing safety goggles in this Operating instructions!

If it is necessary to wear safety glasses, make sure that other people in the room are at an appropriate distance from the device.

2.8 Spare parts

CAUTION



Risk of injury if incorrect spare parts are used!

The use of incorrect or defective spare parts can lead to hazards for personnel, material damage, malfunctions or even complete failure of the device.

- Only use original parts from Witschi Electronic AG or parts approved by Witschi Electronic AG.
- If unclear, contact customer service, see *Technical support* [[Page 7](#)].

Info



For a list of spare parts, see *Accessories and spare parts* [[Page 53](#)].

2.9 Noise emissions

The noise emissions from the ProofMaster CP are below 75 dB(A) and have been measured according to the guidelines EN ISO 3740:2001-03 and EN ISO 11200:2014-10.

3 Initial operation

3.1 Moving the device

CAUTION



Risk of injury and material damage due to improper transport!

In the event of improper transport, the device may fall or tip over. This may cause personal injury or serious damage to property.

Prohibition



Never transport the ProofMaster CP when it is connected or switched on!

Handling may be severely impaired and components of the device may be damaged.

Mandatory



Follow the obligations set out below:

Always transport the packages vertically and never throw them!

Observe the markings on the packaging!

Do not remove the ProofMaster CP from its packaging until shortly before commissioning!

The packaging protects the ProofMaster CP from external damage.

Always carry the ProofMaster CP by the carrying handle or with both hands!

Falling over is prevented.

Only technical personnel are authorised to install the ProofMaster CP!

The technical personnel are trained for proper installation.

3.2 Transport inspection

When accepting the device, check all components and make sure that no parts have been damaged during transport.

Additionally, check whether the device is complete.

Proceed as follows if there is visible transport-related damage:

- a) Do not accept the delivery.
- b) Make a note of the extent of the damage on the transport company's delivery note.
- c) Write a complaint.

Mandatory



Report damage or missing parts to Witschi Electronic AG immediately!

Claims for damages can only be made within the applicable claim periods.

3.3 Storage conditions

Store the device and package under the following conditions:

- Storage temperature -20 °C to +70 °C.
- Relative humidity maximum 80%, no condensation.
- Do not store outdoors.
- Store in a dry and dust-free condition.
- Do not expose to any aggressive media.
- Protect against sunlight.
- Protect against mechanical impact.
- Do not place anything on top of the device packaging.

3.4 Space requirement

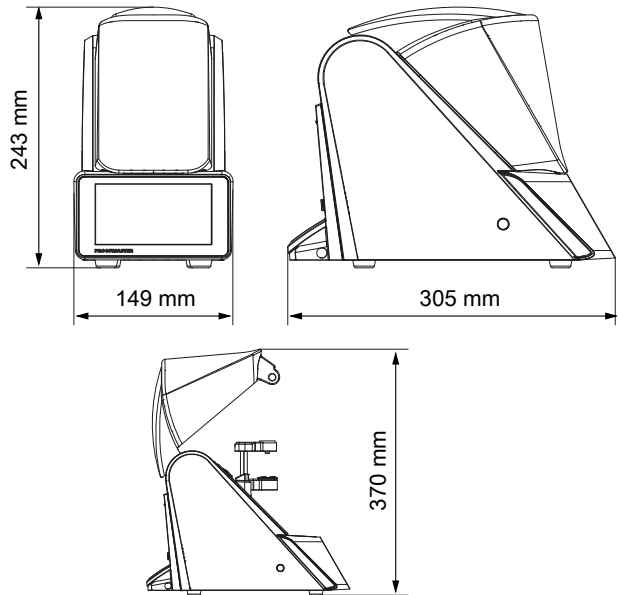

3.5 Requirements regarding the installation site

The ProofMaster CP is designed for use on a worktable in as dry and dust-free an environment as possible. The ProofMaster CP is not suitable for outdoor use.

Caution - material



The results of the tests may be incorrect in the case of an unsuitable installation location!

To achieve precise results, the ProofMaster CP and the test object must be at room temperature.

The following instructions must be observed for reliable measurements:

- Do not position the ProofMaster CP and test object in the vicinity of radiators or open windows.
- Do not expose the ProofMaster CP or the test object to direct sunlight.
- Use the ProofMaster CP on an even and horizontal surface.
- The installation site must be vibration-free.

3.6 Working area of the operator

In order for the operator to work comfortably, we recommend leaving at least 50 cm space on each side of the ProofMaster CP in order to place the watch shop there.

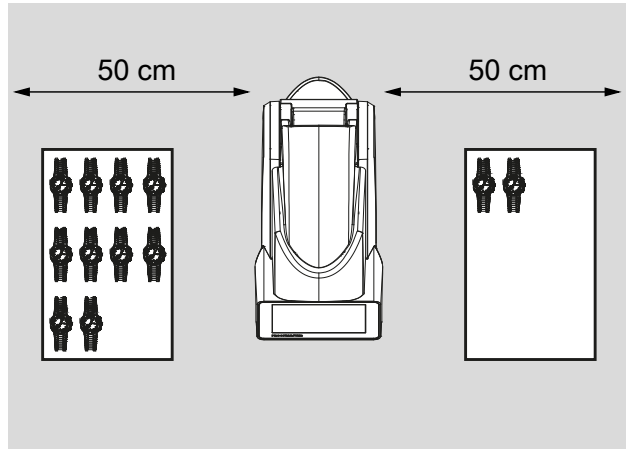

3.7 List of equipment

Equipment included in the scope of delivery for the ProofMaster CP

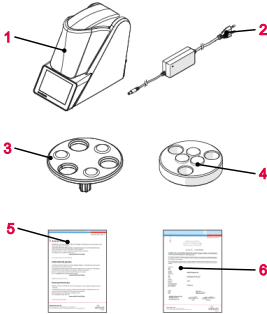

No.	Description	Function
1	ProofMaster CP	Measuring the leak-tightness of watches.
2	Power supply unit (12 VDC, 5 A)	Provides power to the ProofMaster CP.
3	Scratch Protect	Lowerable watch underlay for efficient protection against unwanted scratches.
4	Watch support	Stabilises watches <20 mm during the leak-tightness test.
5	Warranty information	Information on warranty conditions.
6	Calibration certificate	

Optional additional equipment

No.	Description	Function
1	Thermal printer	Prints out the test results without a PC.
2	WiCoTRACE 3 SERVER, SERVER+	Records the test results and manages the programs with a PC.

Info



Please contact the points of sale to order accessories or spare parts.

Your nearest point of sale can be found on the website www.witschi.com.

3.8 Initial operation

Initial operation of the ProofMaster CP includes connecting the power supply and making all other connections for smooth operation (printer, network, etc.).

3.8.1 Current

Caution - material



Risk of material damage if an unsuitable power supply unit is used!

Using an unsuitable or damaged power supply unit can result in a short circuit. This may damage the device.

- Only use the power supply unit supplied with the device.
- Position the power cord so that it cannot be damaged by external influences.

Required equipment

Connecting

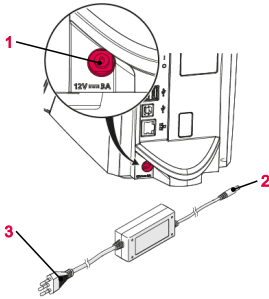

- One ProofMaster CP
 - One power supply unit
- Make sure that the voltage of the local power supply is suitable for the power supply unit.
⇒ 115/230 V, 50 Hz, 1.5 A.
 - Connect the power supply unit connection **2** to the power supply connection of the ProofMaster CP **1**.
 - Connect the power supply unit connection **3** to the local power supply.
- ⇒ The power supply is now connected.

Disconnecting

- Switch off the ProofMaster CP.
 - Disconnect the power supply unit connection **3** from the local mains network.
 - Disconnect the power supply unit connection **2** from the power supply connection of the ProofMaster CP **1**.
- ⇒ The power supply is now disconnected.

3.8.2 Compressed air

The ProofMaster CP has a built-in compressor.

3.8.3 Thermal printer

The following steps are only necessary when using a thermal printer.

Info



Read and follow the instructions supplied with the thermal printer.

**Recommended printer
Required equipment**

Connection with USB cable

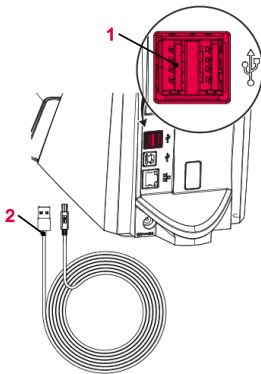

- See section *Accessories and spare parts* [▶ Page 53].
 - ProofMaster CP
 - Thermal printer (not included in the scope of delivery of ProofMaster CP)
 - Standard USB cable type **A–B** or a Bluetooth set II (not included in the scope of delivery of the ProofMaster CP). See *Accessories and spare parts* [▶ Page 53].
- a) Put the thermal printer into operation as specified in the manufacturer's instructions.
 - b) Ensure that the thermal printer and the ProofMaster CP are switched off.
 - c) Connect the USB cable **2** to the thermal printer USB type **B** inputs.
 - d) Connect the USB cable **2** to one of the two USB type **A** inputs on the ProofMaster CP **1**.
 - ⇒ The ProofMaster CP is now connected to the thermal printer.
 - e) Switch on the ProofMaster CP and configure the thermal printer.
 - ⇒ See *Configuring the printer* [▶ Page 71].

Connection via Bluetooth dongle

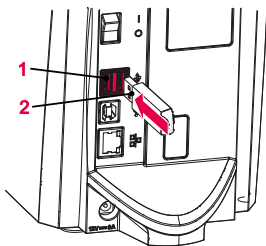

- a) Start the thermal printer incl. Bluetooth plug-in unit as specified in the manufacturer's instructions.
- b) Ensure that the thermal printer and the ProofMaster CP are switched off.
- c) Plug the USB adapter **2** into one of the two USB type **A** inputs of the ProofMaster CP **1**.
 - ⇒ The Bluetooth dongle is automatically recognised by the ProofMaster CP.
 - ⇒ Switch on the ProofMaster CP and configure the thermal printer.
 - ⇒ See *Configuring the printer* [▶ Page 71].

Disconnecting

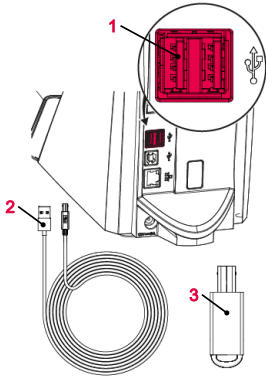

- a) Ensure that the thermal printer and the ProofMaster CP are switched off.
 - b) When connecting using a USB cable, disconnect it from the thermal printer.
 - c) Disconnect the USB cable **2** or the Bluetooth dongle **3** from the ProofMaster CP **1**.
- ⇒ The ProofMaster CP is now no longer connected to the thermal printer.
- ⇒ Configure the ProofMaster CP again without the thermal printer. See [Configuring the printer \[Page 71\]](#).

3.8.4 Network

Required equipment

The following steps are necessary when using a PC within a network.

- ProofMaster CP
- Ethernet cable (not included in the scope of delivery of ProofMaster CP)
- PC incl. network environment (not included in the scope of delivery of ProofMaster CP)

Connecting

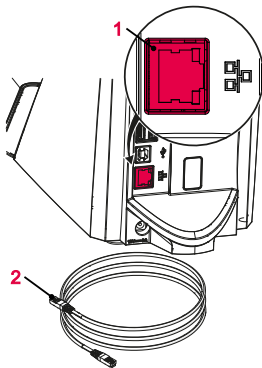

- a) Ensure that the ProofMaster CP is switched off.
 - b) Connect the Ethernet cable **2** to the network.
 - c) Connect the Ethernet cable **2** to the network connection **1** of the ProofMaster CP and switch on the ProofMaster CP.
- ⇒ The ProofMaster CP is now connected to the network.
- ⇒ For the configuration of the network, see the [Network settings \[Page 75\]](#) section.

Disconnecting

- a) Ensure that the ProofMaster CP is switched off.
 - b) Disconnect the Ethernet cable **2** from the network.
 - c) Disconnect the Ethernet cable **3** from the ProofMaster CP.
- ⇒ The ProofMaster CP is now no longer connected to the network.

4 Description

4.1 ProofMaster CP

Front view

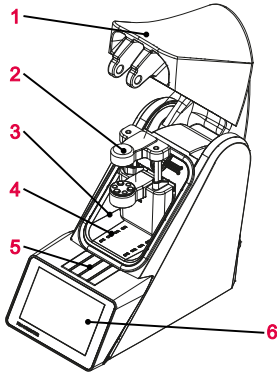

- 1 Bell cover
- 2 Deformation sensor
- 3 Test chamber
- 4 Compressed air inlet and outlet
- 5 Flap over catch
- 6 Touchscreen

The bell cover covers the test chamber. During testing, the bell cover **1** is closed and locked by the catch under flap **5**.

The bell cover opens and closes automatically before and after testing a watch.

Rear view

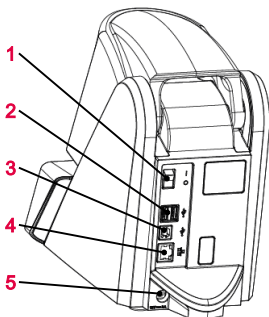

- 1 Main switch
- 2 2x USB type A ports
- 3 USB type B port
- 4 Network connection
- 5 Electrical connection

Test chamber

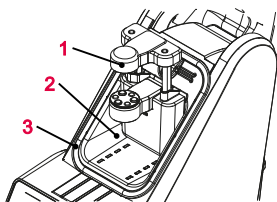

- 1 Deformation sensor
- 2 Test chamber
- 3 Seal (O ring)

The tightness test is performed in the test chamber **2**. The deformation sensor **1** and watch support are located inside the test chamber. When the test procedure is started, the bell cover closes so that it rests against the seal **3**. This ensures that the test chamber is sealed. The pressure required for the test can now be built up and maintained in the test chamber.

The pressure and vacuum are generated by the compressor built into the test chamber.

Deformation sensor

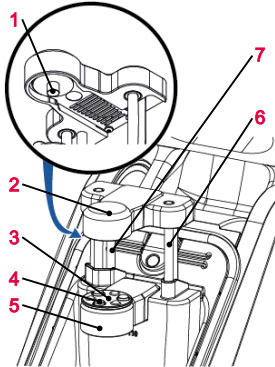

- 1 Measuring probe
- 2 Sensor head
- 3 Scratch Protect
- 4 Support points
- 5 Support table
- 6 Sensor guides
- 7 Driving rods

The deformation sensor makes it possible to measure the deformation of the watch. During the test, the watch is stabilised by the three support points **4** that are integrated in the support table **5**. If a small watch is being tested, the Scratch Protect **3** can be removed and the watch support can be placed on it. The sensor head **2** with the measuring probe **1** is located on the watch glass during the test and can thus measure how strongly the watch housing expands or contracts.

The sensor head **2** is raised or lowered automatically to the watch by the drive rods **7** when the bell cover opens or closes.

Control and display element

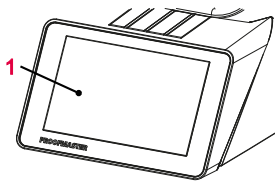

- 1 Touchscreen

Using the touchscreen, it is possible to navigate through the menus and edit the test settings. It also shows the progress and results of the test.

4.2 Included accessories

Power supply unit

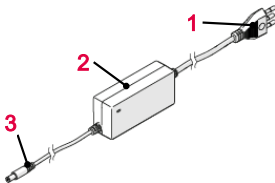

- 1 Power cable (country-specific)
- 2 Transformer
- 3 Power connection (on device)

Item no.: JA01-PSD60E120K3

The ProofMaster CP is connected to the power supply using the power supply unit with the following key figures:

Description	Unit	Value
Input voltage	VAC	100 to 240
Input current	A	1.5
Input frequency	Hz	50 to 60

Description	Unit	Value
Output voltage	VDC	12
Output current	A	5.0

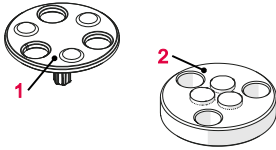
Watch underlay

- 1 Scratch Protect
- 2 Watch support

Item no.: 31.24.702 (watch support) and 31.24.71.40 (Scratch Protect)

The standard support points are suitable for all watches > 20 mm. The Scratch Protect can also be used with these. This scratch protection only lowers the watch once the sensor head is moved to the support points. This prevents scratches when placing the watch.

Scratch Protect cannot be used on small watches because the danger of falling is too great.

Diameter of the watch glass	Watch underlay
$\varnothing_{\text{Glass}} > 20 \text{ mm}$	Scratch Protect 1
$\varnothing_{\text{Glass}} < 20 \text{ mm}$	Watch support 2

4.3 Optional accessories

Thermal printer

The test results can be printed out on the thermal printer. The thermal printer can be connected directly to the ProofMaster CP via the USB cable type A–B or the USB Bluetooth adapter. See *Thermal printer* [▶ Page 23].

Tip



Witschi Electronic AG provides the following components:

Thermal printer, item no. JB01-SLK-TE25-S.
Bluetooth adapter, item no. 95.1510.

- For further information, please contact a point of sale.

WiCoTRACE 3 software

With the WiCoTRACE 3 software, any ProofMaster CP connected to a network can be synchronised via a PC. In the software, all programs for the devices are combined and all measurement results from the connected devices are stored in the WiCoTRACE database. With the Universal Editor, programs can be created globally and used on any connected ProofMaster CP. Connecting to WiCoTRACE, see *WiCoTRACE* [▶ Page 76].

Tip



The WiCoTRACE 3 LITE software can be downloaded free of charge.

www.witschi.com

Bar code reader



The bar code reader can be used in conjunction with the **WiCoTRACE** software. The software can be used to create bar codes or QR codes for the various production orders. When the operator then scans a bar code or QR code, the program and the identification codes are automatically loaded into the ProofMaster CP.

For further details regarding the use of QR codes, see **WiCoTRACE** handbook, server database.

4.4 Procedure of a tightness test

A test may consist of several tests

If a test is performed with multiple tests, the following procedure is repeated.

Determining the initial value

After starting the test, the sensor head is moved into position and the starting value of the deformation is set to zero.

Build up pressure and record the deformation behaviour of the watch housing

The test pressure is built up in the test chamber. In order to compensate for pressure losses caused by the heating of the air, the test pressure is continuously regulated during the measurement.

The deformation behaviour of the watch is continuously recorded during pressure build-up and automatically included in the evaluation algorithm.

Linear deformation behaviour

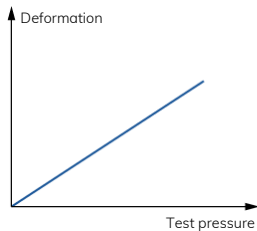

Non-linear deformation behaviour

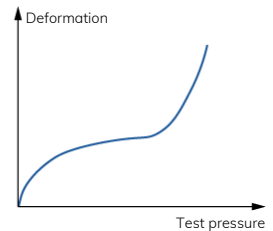

Automatic measuring time

The ProofMaster CP has a new evaluation algorithm which detects elastic deformation in watches and automatically compensates it. In the standard setting, the ProofMaster CP automatically determines the required measuring time for each measurement. The software continues the measurement until a meaningful result is obtained.

The measurement time for a simple OK/not OK statement is shorter than the output of a precise leak rate. It should also be noted that smaller limits lead to longer measurement times. The maximum time per test pressure is limited to 300 seconds with automatic measuring time. For best results in terms of precision and test duration, we recommend the use of the automatic measurement time.

4.5 Definitions

Deformation measurement

The measuring method of the ProofMaster CP is based on the principle of deformation. The watch is subjected to positive pressure to compress the watch housing, or a vacuum to expand it. The faster the deformation is compensated, the larger the leak in the watch case. The deformation of the case within a certain time serves as the basis for the measurement to determine whether the watch is leakproof or not.

Leak-tight watch

Under constant pressure, the deformation of the watch housing remains constant.

Leaky watch

Under constant pressure, the deformation of the watch housing is reduced.

The difference between the pressure in the test chamber and the pressure in the watch housing is being compensated at a rate which is above the limits of the leak rate.

Limit

The limit represents the maximum permissible leak rate. If the leak rate exceeds the predefined limit, the watch being tested is classified as non-leak-tight.

Relative to the diameter of the watch housing, the following standard values apply:

Diameter of the watch glass	Volume	Limit
$\varnothing_{\text{Glass}} < 20 \text{ mm}$	1000 mm ³	50 µg/min
$20 \text{ mm} < \varnothing_{\text{Glass}} < 40 \text{ mm}$	2100 mm ³	
$40 \text{ mm} < \varnothing_{\text{Glass}}$	4000 mm ³	

Info



The lower the leak tightness limit, the longer the measurement takes.

This must be taken into account when planning production.

Leak rate

The ISO 22810 standard specifies the leak rate in µg/min and defines 50 µg/min as the limit value for leak tightness at a test pressure of 2 bar. The ProofMaster CP is configured by default according to these standard specifications.

To calculate the leak rate, the measuring algorithm needs the exact air volume in the watch case. The watch sizes suggested in the measuring program are suitable for a qualitative consideration – we recommend determining the inner volume of the watch beforehand. The inner volume can be determined from the watch's design data.

Info



Negative leak rate

A negative leak rate may be displayed at the start of the measurement.

A negative leak rate can be caused by a number of factors, e.g.:

- Elastic deformation of the test specimen;
- Thermal influences.

Over a longer measurement duration, the ProofMaster CP measurement algorithm compensates for these influences and displays a more accurate result. This makes it more reliable and faster than an algorithm used for conventional deformation measurement.

However, the end result may also display a negative leak rate. This usually occurs with leak-tight test specimens, in which case compensation cannot be fully performed. However, the reliability of the measurement is still guaranteed.

Significant negative leak rates indicate that the automatic compensation was insufficient for the test specimen. Manually setting a longer measurement time may remedy this.

If unclear, please contact customer service, see [Technical support](#) [[Page 7](#)].

4.6 Reference to standard ISO 22810

Leak-tight watch in accordance with standard ISO 22810

Standard ISO 22810 defines that a watch shall be classified as leak-tight if less than 50 µg of air penetrates the watch per minute at a test pressure of 2 bar.

Relationship between volume and deformation

The ISO 22810 standard does not take into account the volume of the watch. This means that the leak rate of 50 µg per minute applies to all watches, regardless of their size.

When testing according to the principle of deformation, the reversion depends on the free volume in the watch. In a watch with a small volume, the reduction in deformation is more pronounced with the same amount of penetrating air. The free volume must be programmed in the watch for a standard-compliant test.

Interpretation of ISO 22810

The standard is based on a pressure of 2 bar or 0.5 bar. No limit value is specified for other pressures. **It is therefore assumed that the limit of 50 µg per minute applies for all test pressures.**

5 Use

5.1 Safety during use

Cracked glass

CAUTION



Risk of injury from cracked glass!

The positive pressure can penetrate into leaking watches during the test. If this is the case, the interior of the watches will be under pressure after the test. The glass in the watch can then splinter or crack. It can cause serious eye injuries and even blindness.

Mandatory



Observe the instructions for wearing safety goggles in this Operating instructions!

If it is necessary to wear safety glasses, make sure that other people in the room are at an appropriate distance from the device.

Risk of crushing

CAUTION



Risk of crushing when closing the bell cover!

There is a risk of crushing between the bell cover and the housing of the device when closing the bell cover.

- Before closing the bell cover, make sure that no body parts or objects are inside the closing area.

5.2 Basic operation

5.2.1 Switch on the ProofMaster CP

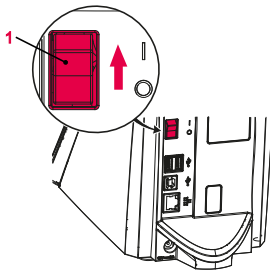

- ✓ The ProofMaster CP has been commissioned correctly, see Initial operation.

- Switch on the ProofMaster CP by pressing the switch **1** in the direction of the arrow.
 - ⇒ The home screen appears.
 - ⇒ The bell cover opens.

Info



When the ProofMaster CP is switched on for the first time, the display language can be selected on the displayed screen.

The display language can be changed at any time, see [Language selection](#) [Page 56].

- ⇒ The "Programs" screen appears.
- ⇒ The ProofMaster CP is ready for operation.

5.2.2 Enabling screen saver or standby

Switching to screen saver or standby

- ✓ The ProofMaster CP is switched on, see [Switch on the ProofMaster CP](#) [Page 32].

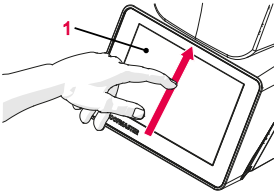

- a) Swipe the touchscreen **1** with your finger in the direction of the arrow.
 - ⇒ The quick setup menu appears.

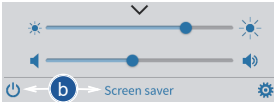

- b) Press "Screen saver" or tap  to switch the ProofMaster CP to standby.
 - ⇒ The bell cover closes and is locked.
 - ⇒ The ProofMaster CP is in standby or screen saver mode (standby screen is always black).
 - ⇒ The screen saver is displayed (date and time in this example).

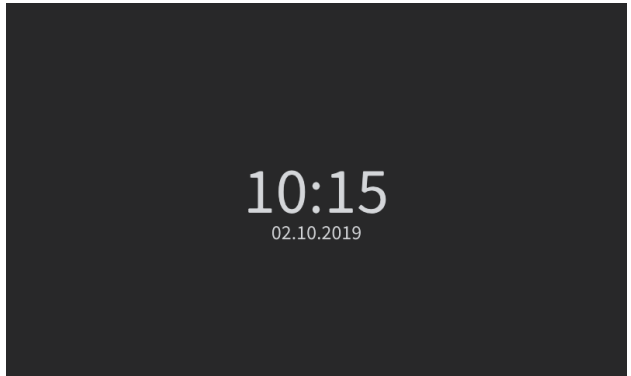

Tip



The screen saver is configurable.

See Screen saver [▶ Page 57].

- ✓ The ProofMaster CP is in standby.

Exiting screen saver/ standby

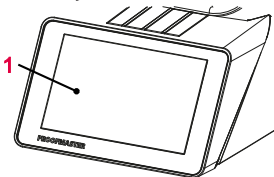

- a) Touch the touchscreen **1** to exit "Standby" or "Screen saver" mode.

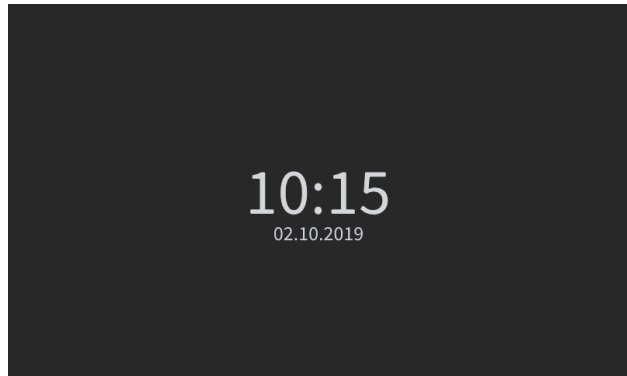

- ⇒ The bell cover opens.
- ⇒ The screen returns to the display that was active before switching to standby.

5.2.3 Switching off the device

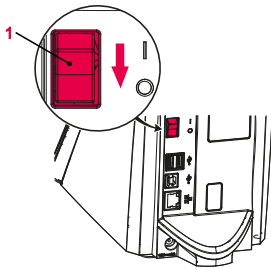

Tip



If the device is not used for a short period of time, enable standby mode.

See [Enabling screen saver or standby](#) [Page 32].

- a) If necessary, remove the watch from the test chamber.
- a) Activate  mode, see [Enabling screen saver or standby](#) [Page 32].
 - ⇒ The bell cover closes and is locked.
- b) Switch off the ProofMaster CP by pressing the switch **1** in the direction of the arrow.
- c) Cover the ProofMaster CP with the corresponding dust cover.

5.2.4 Determining test pressure values

Improper test pressure value settings

Caution - material



Risk of damaging the watch due to improper test pressure value settings!

Observe the following list of prohibitions and obligations.

Prohibition



Do not subject jewellery watches or thin watches to a pressure below -0.3 bar!

If jewellery watches or thin watches are subjected to an excessively strong vacuum, the base or glass of the watch may burst.

Prohibition



Never check a watch with a pressure greater than that specified in the specifications!

The force exerted may damage the watch and, in the case of flexible housings, even the movement.

Mandatory



Observe the table for the effect of force on the watch in order not to apply too high a pressure!

See Effect of force on the watch [► Page 35].

Specifications for test pressure value settings

Observe the following points to achieve optimum results:

- The pressure of the subsequent tests must always be greater than that of the previous test.
- Perform the vacuum test first. The vacuum test can be used to identify defects that cannot be detected by an overpressure test:
 - Insufficient leak tightness of the housing base.
 - Insufficient pressure of the battery cover on the seal.
- Only check watches for which a maximum water depth is specified, and do not exceed this limit value. Observe the following rule: 10 m water depth = 1 bar.
- Check wristwatches without special information at a maximum pressure of 2 bar.

Effect of force on the watch

Watch size	Vacuum (bar)			Pressure (bar)			
	-0.2	-0.4	-0.7	1.0	2.0	5.0	10.0
(Dia. in mm)							
< 20	5.9 N	12.7 N	21.6 N	31.4 N	61.8 N	154.0 N	307.9 N
< 28	11.8 N	24.5 N	42.4 N	60.8 N	120.6 N	302.0 N	604.1 N
< 36	19.6 N	40.2 N	69.6 N	100.0 N	200.1 N	499.2 N	998.3 N

Vacuum

The ProofMaster CP can generate a maximum vacuum of 85% compared to the ambient pressure. The maximum vacuum that can be generated therefore varies depending on the height at which the ProofMaster CP is operated.

The following table shows the maximum vacuum that can be generated depending on the altitude:

Altitude (m)	0	500	1000	1500	2000
Maximum vacuum that can be generated (bar)	-0.85	-0.81	-0.76	-0.72	-0.68

Info





If the vacuum cannot be reached, the following message will appear: "No or insufficient inlet pressure available."

5.2.5 Selecting the program (ProofMaster CP)

Preset programs

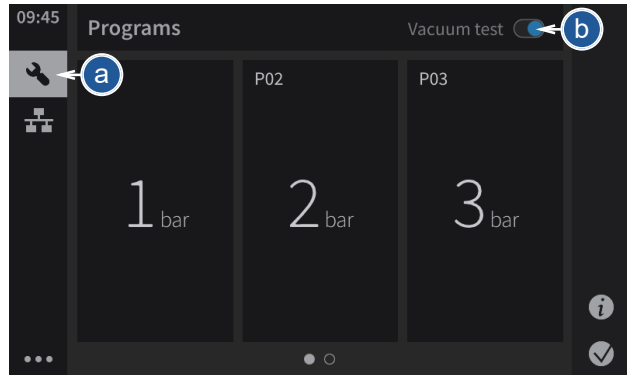
The vacuum test can be activated or deactivated.



- a) Press 
 - ⇒ The Select program screen appears.
- b) Determine whether the vacuum test is to be performed.
 - ⇒ It is possible to deactivate the display for this pop-up.
- c) Press **Activate** to keep the vacuum test or **OK** to deactivate the vacuum test.

Vacuum test is deactivated

The vacuum test is an important part of a comprehensive leak test. It detects leaks at low pressure, which often occurs in everyday situations. It is recommended to activate the vacuum test.

Do not show warning

Activate

OK

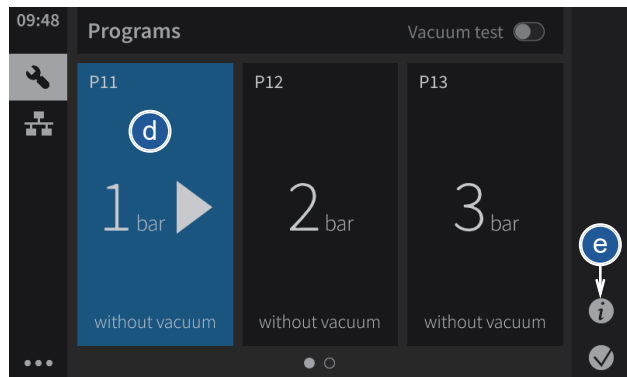

- d) Press the required program in the list or swipe the screen from right to left to select other available programs.
 - ⇒ The selected program is shown in blue.
 - ⇒ The vacuum test is shown or hidden depending on what you have previously selected.
- e) Press Details to see the preset settings for the measurement.

5.2.6 Starting the test

- a) Select the program.
 - ⇒ See Selecting the program and/or Programming a quick test.

CAUTION



Observe all safety regulations for the test pressures in order to avoid accidents and damage to the watch or the ProofMaster CP!

See *Safety regulations* [▶ Page 13].

- b) Positioning a watch on the support.
 - ⇒ See *Positioning the watch* [▶ Page 38].
- c) Press  to start the test.
 - ⇒ The bell cover closes and the test begins.

Info



If one of the test steps fails, the entire test is considered a failure and is aborted immediately.

The bell cover opens.

- d) Follow the test procedure.
 - ⇒ See *Displaying test results* [▶ Page 41].
- e) Wait until the bell cover is open.
 - ⇒ The bell cover opens automatically at the end of the test.
- f) Read the test result.
 - ⇒ See *Displaying test results* [▶ Page 41].

Prohibition



Do not test a leaky watch twice in a row!

Due to the residual pressure inside the watch, the results would be distorted.

Open the watch before the second test to allow the positive pressure to escape.

- g) Remove the watch from the ProofMaster CP.

5.2.7 Cancelling the test

- a) Press  to stop the test.
 - ⇒ The test is stopped, the pressure is released and the bell cover opens.

5.2.8 Positioning the watch

Temperature

Mandatory



The watch must be exposed to the same ambient temperature as the ProofMaster CP during the test.

Temperature fluctuations in the housing during testing may affect the test result.

- Keep the watch next to the ProofMaster CP before testing.
- If the watch has come directly from the user, wait until it has reached the ambient temperature.

Positioning the watch

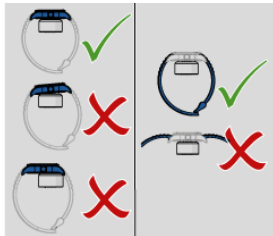
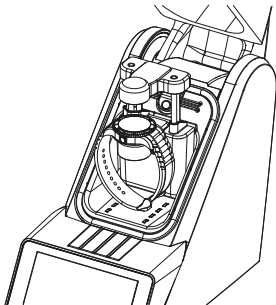
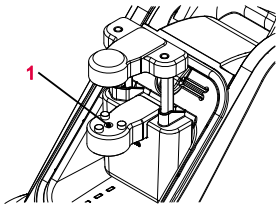

a) Insert the appropriate watch underlay into the opening **1** provided for this purpose.

⇒ See *Included accessories* [▶ Page 27].

b) Remove the protective sticker or label from the housing.

c) Mount the watch on the watch underlay and pay attention to the following points.

d) If the watch back is not flat, turn the watch over and place the glass side on the watch underlay.

e) Position the watch so that the measuring probe can be lowered onto the centre of the watch.

Tip



It is possible to lower and lift the sensor manually.

See *Manually lowering/lifting the sensor* [▶ Page 39].

a) Position the watch strap so that the watch is lying securely on the watch underlay. If necessary, remove the watch strap.

b) Make sure that the watch strap does not come into contact with any parts of the device.

⇒ The watch is positioned horizontally on the three support points.

5.2.9 Manually lowering/lifting the sensor

Depending on the selected menu, it is possible to lower and lift the sensor manually.

Lowering the sensor

- a) Press  to lower the sensor head **1** onto the watch **2**.

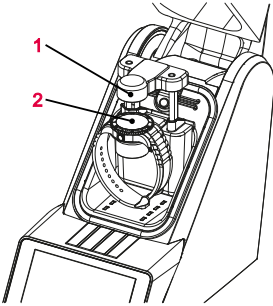

Lifting the sensor

- a) Press  to lift the sensor head **1**.

5.2.10 Identifying the tests

All measurements are identified by the measured test specimen (model). It is possible to add further identification elements:

- Prefix (for example, part number)
- User
- Comment (4 lines with maximum 32 characters)

Enabling identification

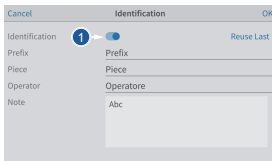

Entering the identification settings

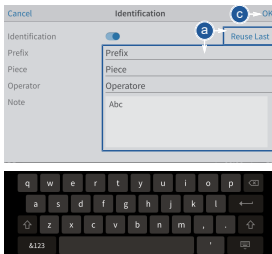

- Press  to open the identification window.
- Enable the identification.
 - ⇒ The button **1** is blue when the function is enabled and grey when it is not.
 - ⇒ The identification parameters entered are saved with the measurement result and also printed on the label.

✓ **The program is selected, Identification is enabled and the Identification menu is displayed.**

- Press **Apply last entries** to fill in the input fields with the settings from the last measurement, or press one of the input fields to open the alphanumeric keypad.
- If necessary, enter the desired settings.
 - ⇒ Use the alphanumeric keypad.
- Press **OK** to confirm the entry.
- Press  to perform the measurement.

5.3 Measurement results

5.3.1 Displaying test results

Info



The only result of a leak test to be displayed is whether the test is good or bad. However, it is also possible to enable leak rate measurement.

See Creating a program.

Test area

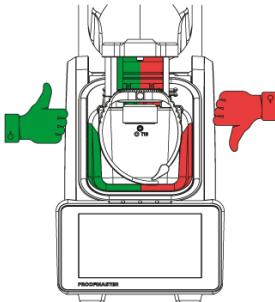

When the bell cover is opened after a leak test, the test area is illuminated green if the test result is good and red if the test result is bad.

Display

Two display types are available for the test result. See Selecting the results display [Page 43].

Numerical display

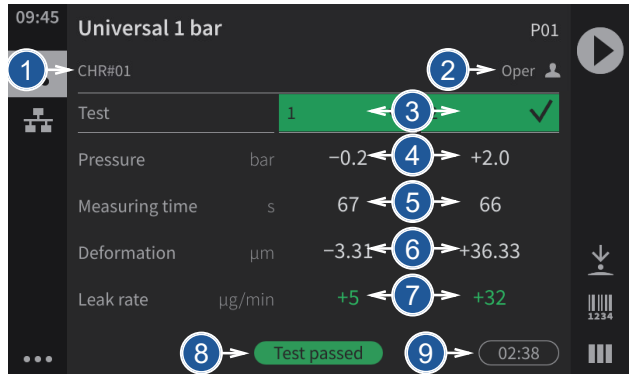

The numeric display provides the following information:

- 1 Test specimen prefix
- 2 Name of the operator (only with enabled identification, in the example above **Opera**)
- 3 Progress and result of each test step
- 4 Pressure values of each test
- 5 Measuring times of each test

- 6 Measured deformations for each test
- 7 Leak rate (only in Precise mode)
- 8 End result of the test
- 9 Total testing period

The following examples show possible display phases.

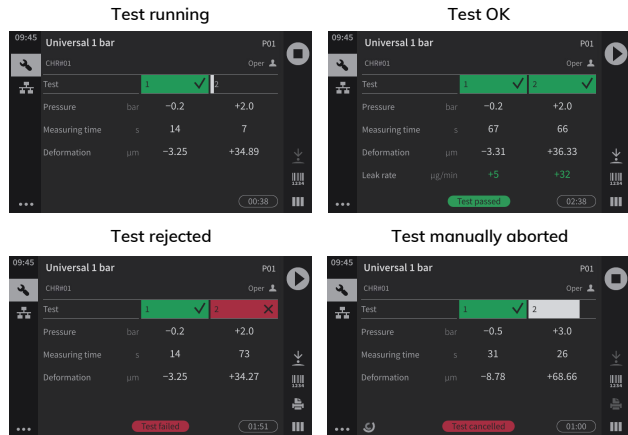

Reduced display

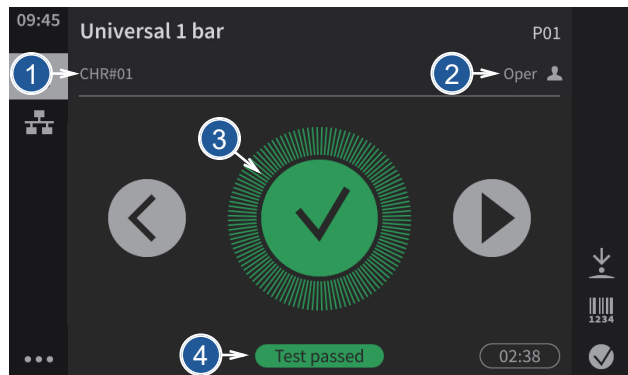

The reduced display provides the following information:

- 1 Test specimen prefix
- 2 Name of the operator (only with enabled identification, in the example above **Opera**)
- 3 Progress and result of each test step
- 4 End result of the test

In the examples below, the first test is running, the second test result is OK and the third test result is not OK.

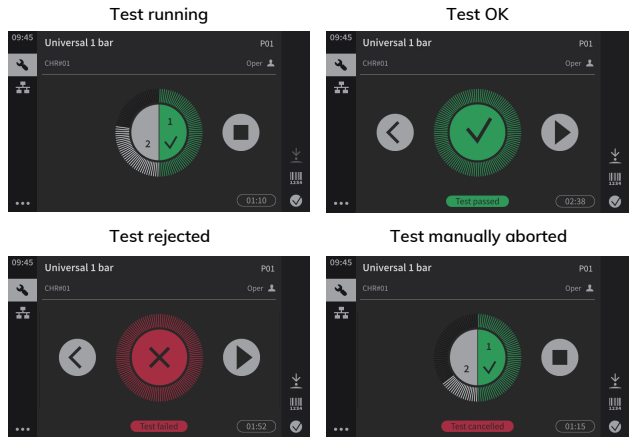

5.3.2 Selecting the results display

The results can be displayed in numeric or reduced form.

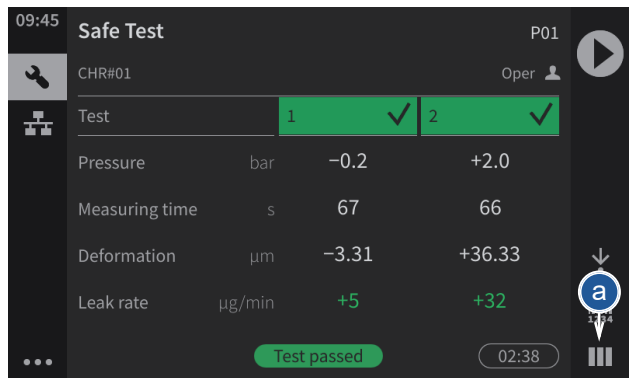

a) Press or (at the bottom right of the screen) to show the results in reduced or a numerical display.

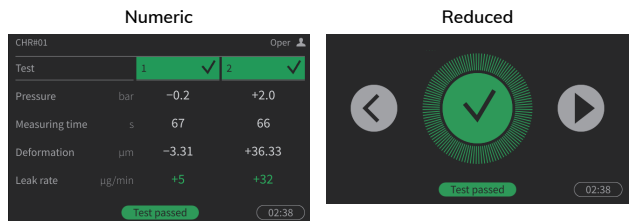

5.4 Programming

5.4.1 Menus and operating buttons

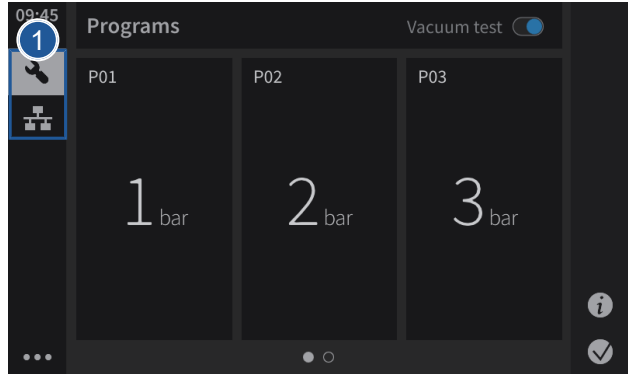

The various function menus can be accessed by pressing the corresponding button **1**:



Programs menu



WiCo menu (appears only when WiCoTRACE is enabled)

Functions of the buttons



Start a test sequence



Stop a test sequence



End the countdown



Numerical display



Reduced display



Expand the menus



Reduce the menus



Bluetooth connection



Lower the sensor



Lift the sensor



Print a label



Programs menu options



Sorting options





Administrator mode



User mode



Select

	Back
	Selected option
	Favourites
	Export
	Import
	Reset
	Standby
	Settings

5.4.2 Preset programs

The ProofMaster CP offers a program type:

- **Preset programs:** Programs predefined by the manufacturer

These are marked with the  symbol.

Abbreviation	Program name	Info on program
P01	Universal 1 bar	Minimum pressure for delicate watches or watches that deform significantly (e.g. plastic watches).
P02	Universal 2 bar	Universal test for all types of watches that are classified as waterproof. Corresponds to the 2 bar test as per ISO 22810:2010-4.4 and ISO 6425:2018-B.1.1.
P03	Universal 3 bar	For all types of watch that are classified as water-resistant to 3 ATM/30 m.
P04	Universal 5 bar	For all types of watch that are classified as water-resistant to 5 ATM/50 m.
P11	Universal NoVac 1 bar	Minimum pressure for delicate watches or watches that deform significantly (e.g. plastic watches). Without vacuum test.
P12	Universal NoVac 2 bar	Universal test for all types of watches that are classified as waterproof. Corresponds to the 2 bar test as per ISO 22810:2010-4.4 and ISO 6425:2018-B.1.1. Without vacuum test.
P13	Universal NoVac 3 bar	For all types of watch that are classified as water-resistant to 3 ATM/30 m. Without vacuum test.
P14	Universal NoVac 5 bar	For all types of watch that are classified as water-resistant to 5 ATM/50 m. Without vacuum test.
P99	Calibrated Leak	For testing the function of the ProofMaster CP in combination with Witschi reference leaks.

Parameters for the preset programs

Abbreviation	Program name	Pressure values (bar)	Limit values ($\mu\text{g}/\text{min}$)	Watch size (mm)
P01	Universal 1 bar	-0.2 / 1.0	200 / 50	20 - 40
P02	Universal 2 bar	-0.3 / 2.0	200 / 50	
P03	Universal 3 bar	-0.4 / 3.0	200 / 50	
P04	Universal 5 bar	-0.5 / 5.0	200 / 50	
P11	Universal NoVac 1 bar	1.0	50	
P12	Universal NoVac 2 bar	2.0	50	
P13	Universal NoVac 3 bar	3.0	50	
P14	Universal NoVac 5 bar	5.0	50	
P99	Calibrated Leak	2.0	50	

Info



The 50 $\mu\text{g}/\text{min}$ limit is only applied at the highest test pressure of a program, as per ISO 22810. The previous test pressures are tested for the preliminary test with a limit of 200 $\mu\text{g}/\text{min}$.

5.5 ChronoMaster Air

5.5.1 Connecting the ChronoMaster Air

With the Bluetooth dongle

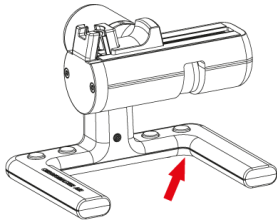

- ✓ The ChronoMaster Air is connected via the Bluetooth dongle, see [ChronoMaster Air \(establishing a connection for Bluetooth\)](#) [[Page 78](#)].
- a) Switching on the ChronoMaster Air (switch under the base).
 - ⇒ The **ChronoMaster** menu is displayed in the bottom left of the screen.



With the USB cable

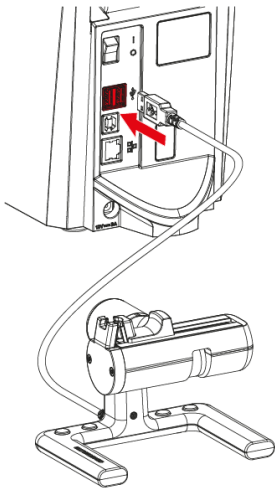

- ✓ The ProofMaster CP is switched on, see [Switch on the ProofMaster CP](#) [[Page 32](#)].
- a) Insert the USB connector for the ChronoMaster into an unused USB port on the ProofMaster CP.
 - ⇒ The **ChronoMaster** menu is displayed in the bottom left of the screen.



5.5.2 Starting the measurement

- ✓ The ChronoMaster is connected to the ProofMaster CP; see [Connecting the ChronoMaster Air](#) [[Page 47](#)]

- a) Open the clamping jaws.
- b) Insert the calibre, ensuring that the winding stem is next to the microphone.
- c) Release the clamping jaws.
- d) Press  to start a measurement.

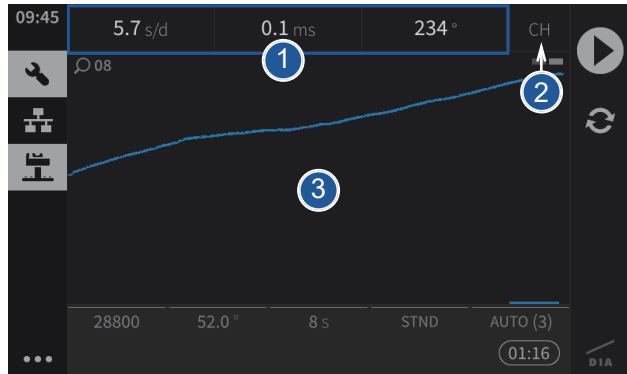

- 1 Display of the current measurement data
- 2 Measuring position of the calibre
- 3 Graphic display of the diagram

5.5.3 Configuring the measurement

- a) Press  (at the bottom left of the screen) to display the ChronoMaster menu.
 ⇒ The screen for configuring the measurement appears.

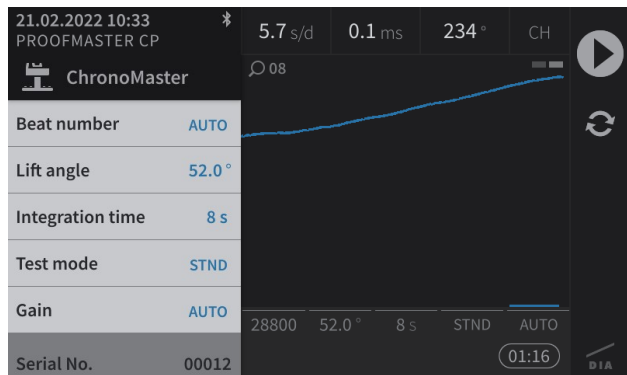

Info



The serial number of the ChronoMaster is displayed at the bottom of the menu.

Beat rate

Beat number AUTO

- a) Press **Beat rate**.
 - ⇒ The selection of the test beat rate appears.
 - Auto:** Automatic determination of beat rate;
 - Freq:** Automatic determination of beat rate for rate deviation = 0 s/d;
 - Manual:** Manual determination of beat rate. Range from 3600 to 7200 A/h;
 - Fixed:** 18000; 19800; 21600; 25200; 28800; 36000; 72000 A/h.
- b) Press the required beat rate or press **Auto, Freq** or **Manual**.
 - ⇒ The selected beat rate (Auto) is displayed.

Lift angle

Lift angle 52.0°

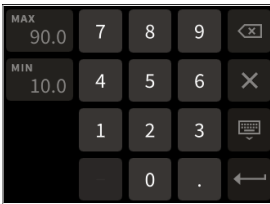

- a) Press **Lift angle**.
 - ⇒ A number field appears.
- b) For an individual lift angle, enter the desired value between 10° and 90° and then press  to confirm the entry.

Integration time

Integration time 8 s

- a) Press **Integration time**.
 - ⇒ The selection of the integration time appears. Here, you can select the integration time for which the numeric results are calculated in the diagram.
 - ⇒ **4 A:** 4 vibrations/hour;
 - 2 s to 60 s:** Value in seconds.
- b) Press the required integration time.

Test mode

Test mode STND

- a) Press **Test mode**.
 - ⇒ The selection of the test modes appears.
 - ⇒ **STND:** Mode for watches with a Swiss lever escapement;
 - GANG:** Mode for rate measurement on watches with cylinder escapement, duplex escapement or detent escapement, as well as watches making unusual noises while beating;
 - SPE1:** Mode for watches with a coaxial escapement;
 - SPE2:** Mode for watches with an AP escapement.
- b) Press the required test mode.

Increase

Gain AUTO

- a) Press **Increase**.
 - ⇒ The selection of the test increase values appears.
- b) Press the required increase.
 - ⇒ For watches with no particular measurement problems, we recommend using the **AUTO** function.

6 Maintenance

6.1 Safety during maintenance

Improper maintenance

Prohibition



Never force the device cover to open when the device is under pressure!

Otherwise parts could be ejected.

Mandatory



Observe the documentation of the compressor manufacturer!

To avoid operating errors that can lead to damage.

Short circuit

Caution - material



Danger of material damage due to short circuit!

Damage to the insulation on the power cord or the power supply unit can result in a short circuit and damage the ProofMaster CP.

Prohibition



Never immerse the ProofMaster CP in water!

This will destroy the device.

Mandatory



Follow the obligations set out below:

Work on electronic components of the ProofMaster CP must only be carried out by the customer service of Witschi Electronic AG!

Failure to comply with this requirement will void the warranty.

Place the power cord so that it cannot be damaged by external influences.

This avoids the risk of damaging the power cord or power supply unit.

If any of the components are damaged, disconnect the mains plug and have the power supply unit repaired.

Always disconnect the mains plug before cleaning, maintenance or repair work!

Ensure that access to the power supply is always guaranteed.

To disconnect the power supply unit from the power supply, only pull on the plug itself, never pull on the cable.

Protect live parts from moisture!

Moisture can cause a short circuit.

6.2 Maintenance schedule

Caution - material



Risk of damage to the ProofMaster CP due to insufficient servicing of the compressor!

Failure to service the compressor may result in contamination of the compressed air by oils harmful to the ProofMaster CP.

- Service the compressor as specified in the manufacturer's documentation.
- Make sure to comply with the maintenance cycles specified in the following maintenance schedule.

⇒ Non-compliance will void the warranty.

Info



The following maintenance schedule is intended for the operator of the ProofMaster CP.

Maintenance of the ProofMaster CP does not require a specialist technician.

Interval	Maintenance task	Personnel
Daily	Clean the seal with a dry microfibre cloth.	Operator
	Check that the compressed air hose is secure and in good condition.	
	Make sure that the bell cover is closed at the end of the day. See <i>Switching off the device</i> [Page 34].	
Annually (recommended)	Have the ProofMaster CP recalibrated. To do so, contact the point of sale. See <i>Technical support</i> [Page 7]. For calibration, the deformation sensor can be sent individually or installed with the ProofMaster CP. See <i>Replacing the deformation sensor</i> [Page 52].	Customer service
After 200,000 tests or every 8 years, at the latest	An inspection must be carried out on the ProofMaster CP. The message "Inspection required. Call Witschi service" appears when starting the ProofMaster CP. To do so, contact the point of sale. See <i>Technical support</i> [Page 7]. Comment The number of tests since initial commissioning can be found in the menu Settings > Info > Operating information .	Customer service

6.3 Cleaning the seal (O ring)

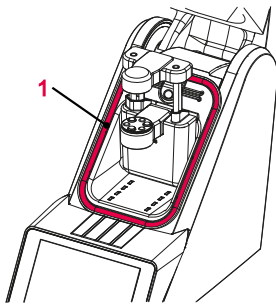

- ✓ The ProofMaster CP is switched off and the bell cover is open.
- a) Clean the seal **1** with a microfibre cloth.

6.4 Replacing the seal (O ring)

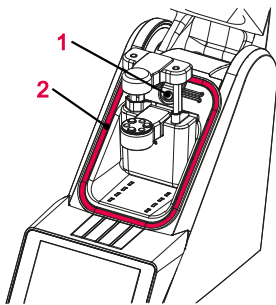

- ✓ The ProofMaster CP is switched off and the bell cover is open.
- a) Lift the seal **2** with the push button **1** and remove by hand.
- b) Remove dust particles and other deposits from the seal groove **2**.
- c) Insert a new seal **2**.

6.5 Replacing the deformation sensor

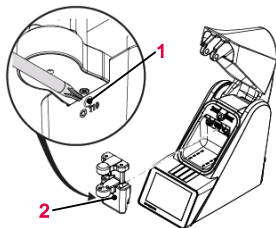

- ✓ The ProofMaster CP is switched off and the bell cover is open.
- a) Unscrew screw **1** with a T10 Torx screwdriver.
- b) Remove the deformation sensor **2**.
- c) Hook in the new deformation sensor **2**.
- d) Tighten screw **1**.

6.6 Accessories and spare parts

Ordering spare parts

To order accessories or spare parts, please contact *Technical support* [[Page 7](#)].

Your nearest point of sale can be found on our website www.witschi.com.

Printing

Accessories	Item no.
Thermal printer	JB01-SLK-TE25-S
Bluetooth Set II to Printer (Plug-in unit + dongle)	95.1511
USB Bluetooth dongle (for additional ProofMaster devices)	JB15-BT851
Spare thermal paper roll for JB01-SLK-TE25-S	JB01-MM60-740RS

Software

Accessories	Item no.
WiCoTRACE 3 SERVER	64.6110
WiCoTRACE 3 SERVER+	64.6210

Power supply unit

Accessories	Item no.
Power supply unit 100–240 VAC/12 VDC/36 W	JA01-PSD40E120K3

Accessories

Accessories	Item no.
Seal (O ring) of the bell cover	NA04-OR138x05
Support for small watches	31.24.702
Protective cover	31.24.04.30
USB cable, 1.8 metres	JB03-11.02.8818
Bar code reader	JB15-GD4520-BKK1S

7 Settings

7.1 Quick settings menu

Opening the quick settings

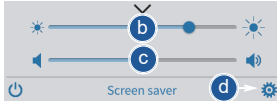
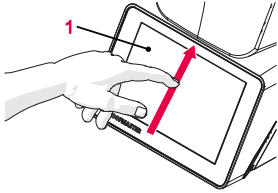

Closing the quick settings

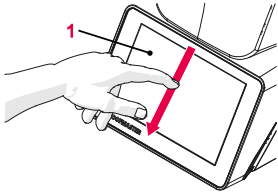

✓ The ProofMaster CP is switched on, see [Switch on the ProofMaster CP](#) [Page 32].

a) Swipe the touchscreen **1** with your finger in the direction of the arrow.

⇒ The quick settings appear.

b) Move the cursor left to decrease the brightness and right to increase the brightness.

c) Move the cursor left to decrease the volume and right to increase the volume.

d) Press  to open the Settings menu.

a) Swipe the touchscreen **1** with your finger in the direction of the arrow.

⇒ The settings window is closed.

Tip



Additional display and audio settings can be made.

See [Display and audio settings](#) [Page 59].

7.2 Settings

The settings of the ProofMaster CP can be changed in the settings. Proceed as follows to access the settings:

The ProofMaster CP offers quick access – see the *Quick settings menu* [▶ Page 54] – and conventional access to the configuration menu settings.

Info



The functions of the keys are described in the *Menus and operating buttons* [▶ Page 44] section.



- a) Press (at the bottom left of the screen) to display the expanded menu.
 - b) Press to access the settings.
- ⇒ The settings menu is displayed.

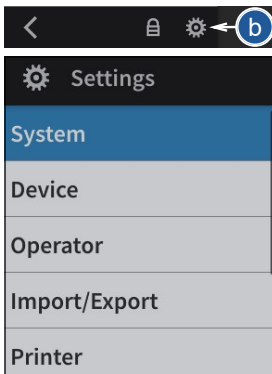

7.3 System

7.3.1 Language selection

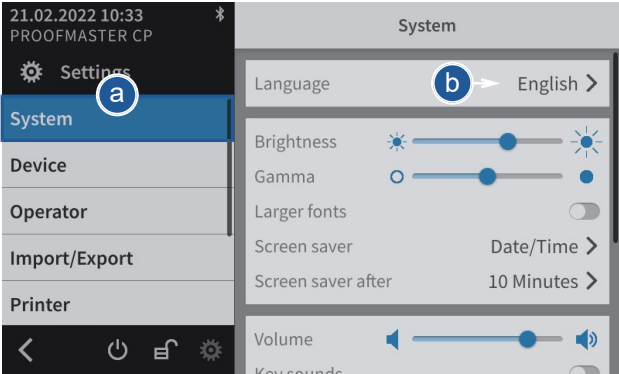

The screenshot shows the Settings application interface. On the left, a vertical menu lists various settings categories: Settings (with a gear icon), System (highlighted in blue and marked with a circled 'a'), Device, Operator, Import/Export, and Printer. On the right, the 'System' settings window is open, showing options like Language (set to English and marked with a circled 'b'), Brightness, Gamma, Larger fonts, Screen saver, and Volume. Below the main screenshot, a separate window shows a list of languages: Deutsch, English (with a blue checkmark), Français, Italiano, and Español.

a) Select **System** from the list.
⇒ **System** is highlighted in blue and the right window displays the system options.

b) Tap the display language to open the selection window.

c) Select the desired display language from the list.

7.3.2 Screen saver

If the automatic screen saver function of the ProofMaster CP is activated, the bell cover closes after the "Enable after" time set on the ProofMaster CP and the screen saver is displayed.

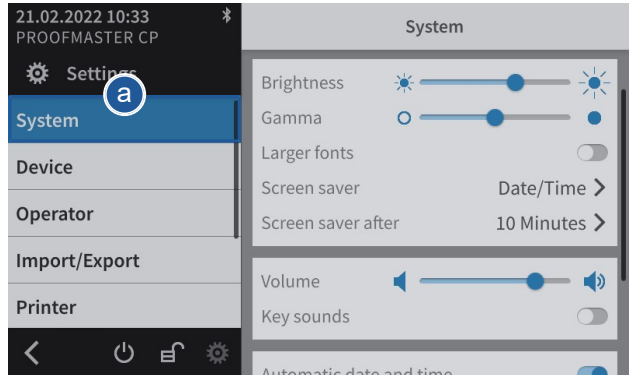

- a) Select **System** from the list.
 - ⇒ **System** is highlighted in blue and the right window displays the system options.
- b) Configure the automatic screen saver according to your needs.
 - ⇒ See the details below for the settings of each option.

Selecting the screen saver

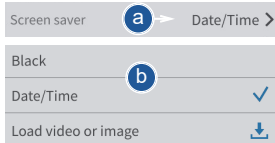

- a) Open the screen saver selection by tapping the current selection.
- b) Choose between a black screen saver and a screen saver with date and time. Alternatively, it is possible to import a screen saver.

Importing a screen saver

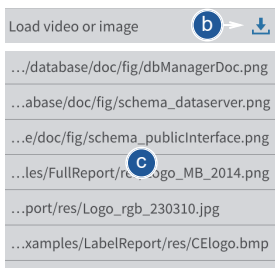

- a) Insert a USB stick with the desired screen saver into the ProofMaster CP.
- b) Press to display the pictures and videos on the USB stick.
- c) Select the desired picture or video from the list.
 - ⇒ The display returns to the screen saver selection screen.
 - ⇒ The selected image or video appears in the screen saver selection list.

Screen saver	Supported formats	Optimum resolution	Description
Images	PNG, BMP, JPG, JPEG	800x480	Images with other resolutions must be resized.
Videos	MP4	800x480	Videos in another aspect ratio are displayed with a black bar. It may not be possible to play high-resolution videos.

Deleting a screen saver

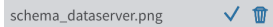

Enabling automatic standby of the ProofMaster CP.

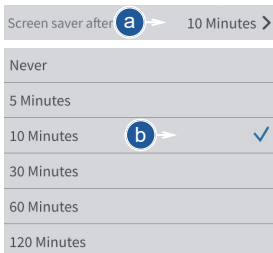

Info



Only imported screen savers can be deleted.

The black screen saver and the screen saver with date and time are system configurations.

- a) Select the imported screen saver to be deleted.
- b) Press  to delete the desired imported screen saver.
- a) Enable or disable the screen saver display.
- b) Select the desired time.

7.3.3 Display and audio settings

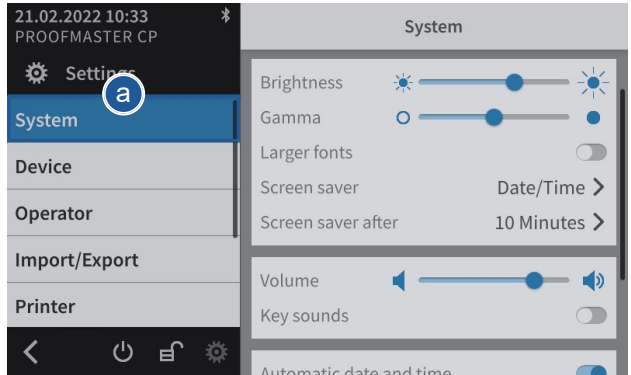

a) Select **System** from the list.
 ⇒ **System** is highlighted in blue and the right window displays the system options.

b) Configure the display and audio settings as needed.
 ⇒ See the details below for the settings of each option.

a) Move the cursor left to decrease the brightness and right to increase the brightness.

a) Move the cursor left to decrease the contrast and right to increase the contrast.

a) Enable or disable the large font display.
 ⇒ The button is blue when the function is enabled and grey when it is not.

a) Move the cursor left to decrease the volume level and right to increase the volume level.

a) Enable or disable the button sound.
 ⇒ The button is blue when the function is enabled and grey when it is not.

Brightness



Contrast



Font sizes

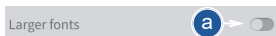

Volume level



Enabling the button sound

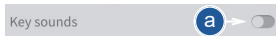

7.3.4 Date & time

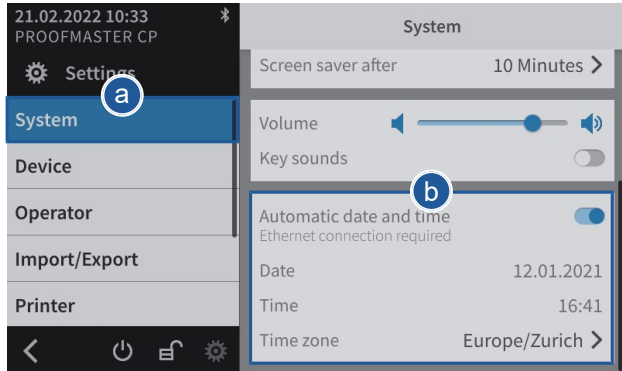

- a) Select **System** from the list.
 - ⇒ **System** is highlighted in blue and the right window displays the system options.
- b) Set the date and time.
 - ⇒ See the details below for the settings of each option.

Automatically setting the date and time

When this function is enabled, the date and time of the unit are set automatically.

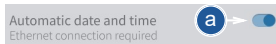

Setting the date manually

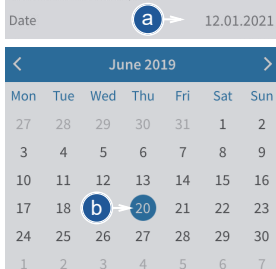

Setting the time manually

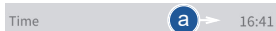

Mandatory



The ProofMaster CP must have an Internet connection!

- a) Enable or disable the automatic setting of the date and time.
 - ⇒ The button is blue when the function is enabled and grey when it is not.
- ✓ **The automatic setting of the date and time is disabled.**
 - a) Open the date selection by tapping the displayed date.
 - b) Select the desired date in the calendar.

- ✓ **The automatic setting of the date and time is disabled.**
 - a) Open the time selection by tapping the displayed time.

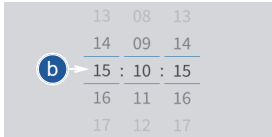

Setting the time zone manually

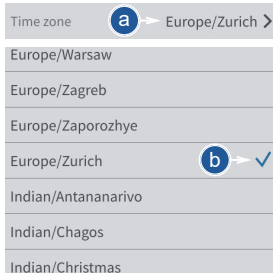

b) Select the desired time.

✓ The automatic setting of the date and time is disabled.

a) Open the time zone selection by tapping the displayed time zone.

b) Select the desired time zone.

7.3.5 Software update

With the further development of the ProofMaster CP, the software will also be improved. It is possible to configure an automatic update of the software. The ProofMaster CP must have an Internet connection in order to be able to communicate with the Witschi Electronic AG update server.

Info

Information on how to download the updates can be found on our website at www.witschi.com.

When you register your ProofMaster CP on our website, we will personally notify you of important updates.

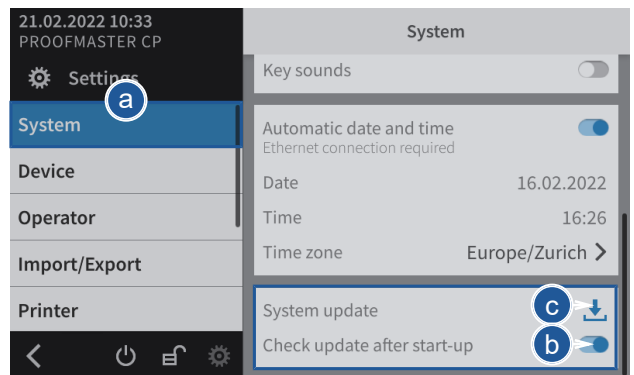

✓ Using an Ethernet cable, connect the ProofMaster CP to a network that has access to the Internet.

a) Select **System** from the list.

- ⇒ **System** is highlighted in blue and the right window displays the system options.
- b) The user can configure the system so that it checks whether there is an update available when it is switched on.
 - ⇒ The button is blue when the function is enabled and grey when it is not.
- c) Or press to look for an update.

After start-up or a search

Update available

A new update is available.
Should the update be installed?

Yes
No

When the update is accepted, the device will automatically install the new software. The ProofMaster CP must not be switched off during the update.

With the USB stick

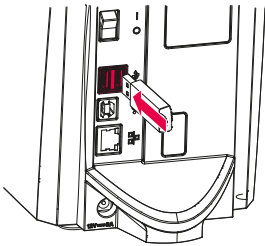

- a) Insert the USB stick with the update files for the ProofMaster CP.

ProofMaster Firmware Updater v1.0

Tasks complete			
Subtask complete			
Module	Current version	New version	Status
Operating system	1.0	1.0	OK
Main core	1.0	1.1	Pending
Pressure core	1.0	1.1	Pending
Capteur core	1.0	1.1	Pending
UI core	1.0	1.1	Pending

Update

- b) Press **Update**.

7.4 Device

7.4.1 Opening speed of the bell cover

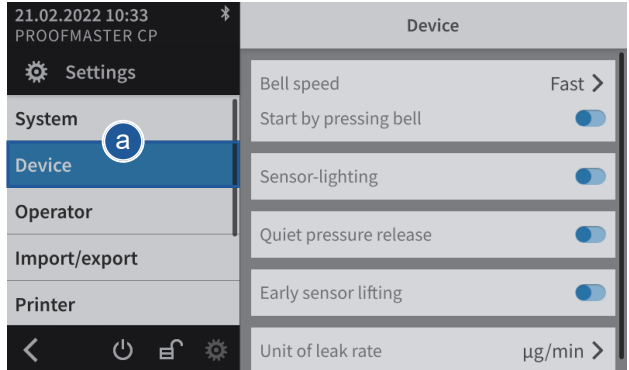

a) Select **Device** from the list.
 ⇒ **Device** is highlighted in blue and the right window displays the device options.

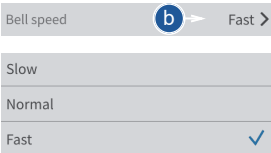

b) Open the bell cover speed selection by tapping the current selection.
 c) Select the desired bell cover speed.

7.4.2 Start by pressing the bell cover

Using this function, a measurement can be started by pressing the bell cover.

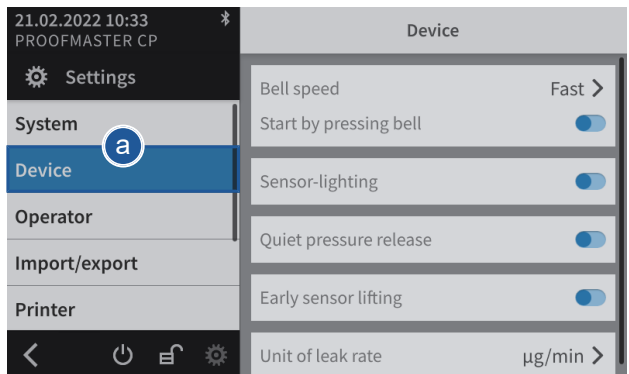

a) Select **Device** from the list.

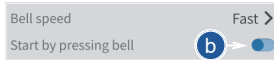

⇒ **Device** is highlighted in blue and the right window displays the device options.

- b) Activate or deactivate the function **Start by pressing the bell cover**.

⇒ The button is blue when the function is enabled and grey when it is not.

7.4.3 Sensor lighting

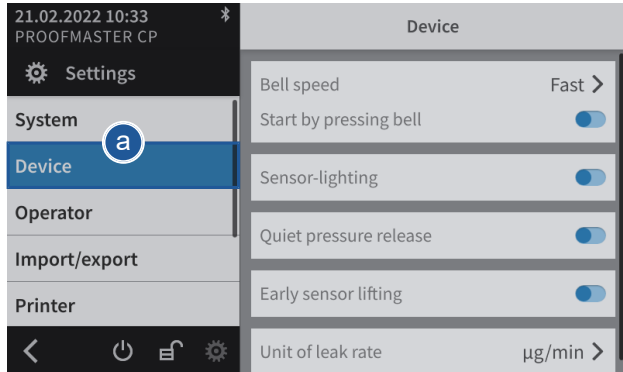

- a) Select **Device** from the list.

⇒ **Device** is highlighted in blue and the right window displays the device options.

- b) Enable or disable the **sensor lighting**.

⇒ The button is blue when the function is enabled and grey when it is not.



7.4.4 Quiet pressure release

This setting allows the test pressure to be released more slowly from the test chamber.

This reduces the noise emission but increases the test time.

For a test at 10 bar, the sound level is reduced from 75 dB(A) to 68 dB(A) and the discharge can be increased by 15 seconds.

7.4.5 Unit of leak rate

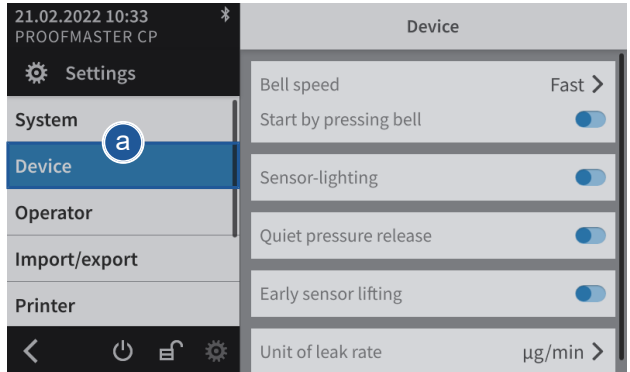

- a) Select **Device** from the list.
 ⇒ **Device** is highlighted in blue and the right window displays the device options.
- b) Open the unit selection for the leak rate by tapping the current selection.
- c) Select the desired leak rate unit.

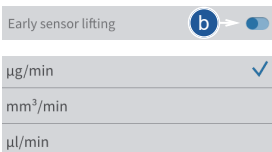

7.5 Import/export

7.5.1 Importing/exporting settings

The ProofMaster CP allows you to import and export these settings using a USB stick. This means settings created can be transferred to other devices.

Exporting

- a) Insert the USB stick on which the settings are to be stored in the ProofMaster CP.

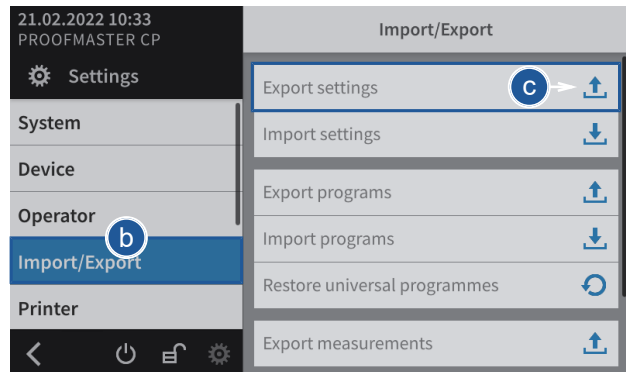
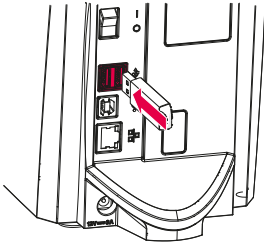

- b) Select **Import/export** from the list.
 ⇒ **Import/export** is highlighted in blue and the right window displays the import/export options.
- c) Press  **Export settings**.
 ⇒ A window appears confirming the successful completion of the settings export.
 ⇒ The settings of the ProofMaster CP were exported to the USB stick in the **config.json** file.
- d) Remove the USB stick.

Export settings
Settings exported successfully.

OK

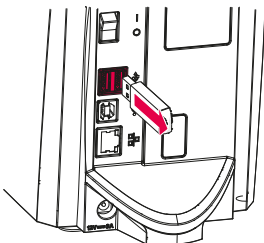

Importing

a) Insert a USB stick with the settings into the ProofMaster CP.

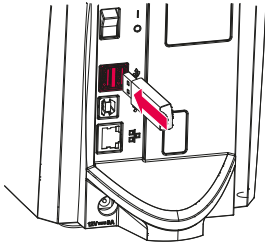

Mandatory



The settings to be imported must be combined in a file with the file name config.json. The file is created by carrying out an export.

Otherwise the ProofMaster CP will not find the settings to import.

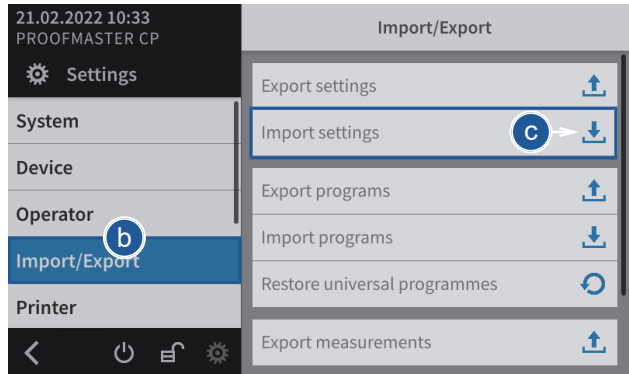

b) Select **Import/export** from the list.

⇒ **Import/export** is highlighted in blue and the right window displays the import/export options.

c) Press  **Import settings**.

⇒ An information and confirmation window appears.

d) Press **OK** to confirm.

⇒ The settings of the ProofMaster CP have been replaced by the settings imported from the USB stick.

⇒ The ProofMaster CP restarts.

e) Remove the USB stick.

Import settings

All settings are overwritten. Results and programs are retained. The instrument is restarted.

OK

Cancel

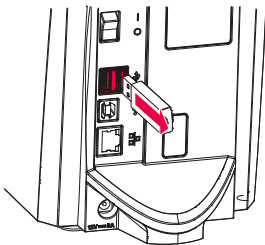

7.5.2 Exporting measurements

Info





This function is intended for analysis by Witschi Electronic AG Customer Service.

The ProofMaster CP allows you to export measurement data using a USB stick. This enables the measurements that have been performed to be analysed by Witschi Electronic AG.

Exporting

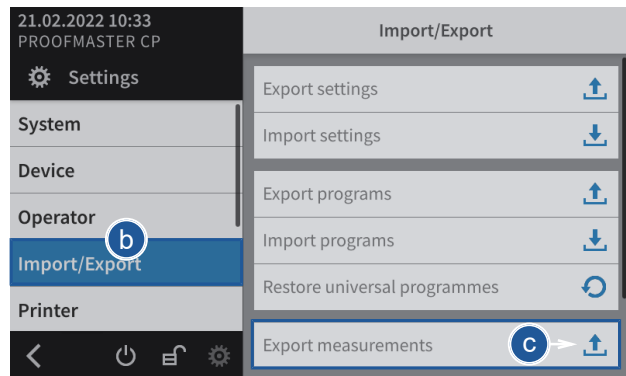
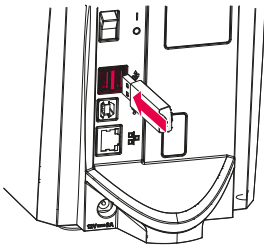
- a) Insert the USB stick on which the measurement data is to be stored in the ProofMaster CP.



- b) Select **Import/export** from the list.
- ⇒ **Import/export** is highlighted in blue and the right window displays the import/export options.
- c) Press  **Export measurements**.
- ⇒ A window appears confirming the successful completion of the measurement data export.
 - ⇒ The measurement data of the ProofMaster CP has been exported to the USB stick in the **mesures.json** file.

Export measurements

Measurements exported successfully.

OK

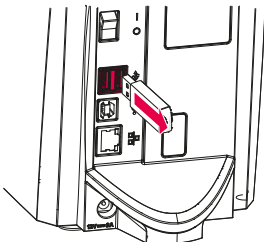

- d) Remove the USB stick.

7.5.3 Resetting the device settings

This process restores the factory settings of the ProofMaster CP. The programs and test results are retained.

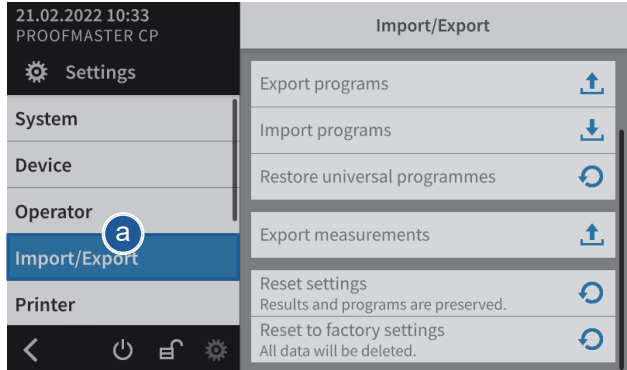

- a) Select **Import/export** from the list.
 - ⇒ **Import/export** is highlighted in blue and the right window displays the import, export and recovery options.
- b) Press  to reset the settings of the ProofMaster CP.
 - ⇒ A confirmation window appears.
- c) Press **OK** to confirm.
 - ⇒ The ProofMaster CP restarts.

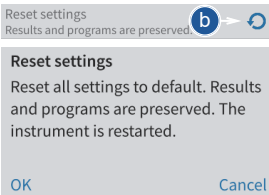

7.5.4 Restoring factory settings

This process restores the factory settings of the ProofMaster CP and deletes all program data, measurement results, etc. on the device.

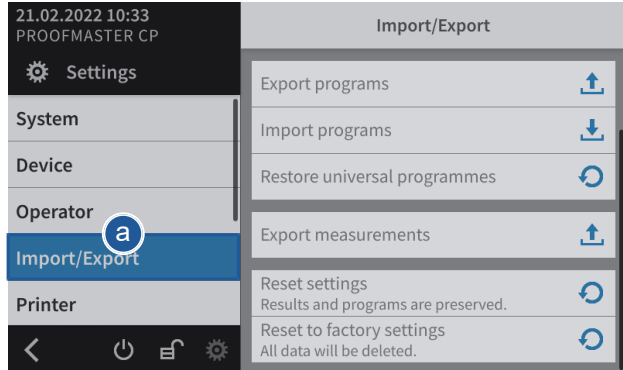

- a) Select **Import/export** from the list.
 - ⇒ **Import/export** is highlighted in blue and the right window displays the import, export and recovery options.
 - ⇒ Press  to restore the factory settings of the ProofMaster CP.
 - ⇒ A confirmation window appears.
- b) Press **OK** to confirm.
 - ⇒ The ProofMaster CP restarts.

Reset to factory settings
All data will be deleted.



Reset to factory settings

Reset your device to factory settings. This deletes all data including programs and results. The instrument is restarted.

OK

Cancel

7.6 Printer

7.6.1 Configuring the printer

The configuration of the thermal printer is carried out on the ProofMaster CP.

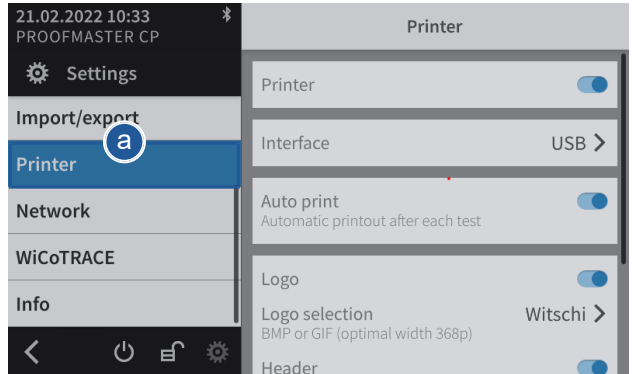

- a) Select **Printer** from the list.
 - ⇒ **Printer** is highlighted in blue and the right window displays the device options.
- b) Enable the printer.
 - ⇒ The button is blue when the function is enabled and grey when it is not.
- c) Open the user interface display by tapping the current selection.
- d) Select the connection type.
 - ⇒ In the following example, Bluetooth.
- e) Press < **Printer** to save and return to the previous screen.
- f) If necessary, enable automatic printing.
 - ⇒ The button is blue when the function is enabled and grey when it is not.
- g) If necessary, configure the label.
 - ⇒ See [Configuring the label](#) [Page 72].

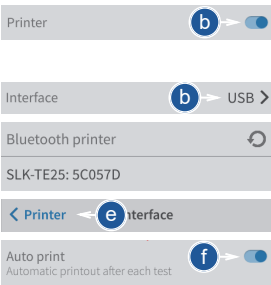

7.6.2 Configuring the label

Configurable areas

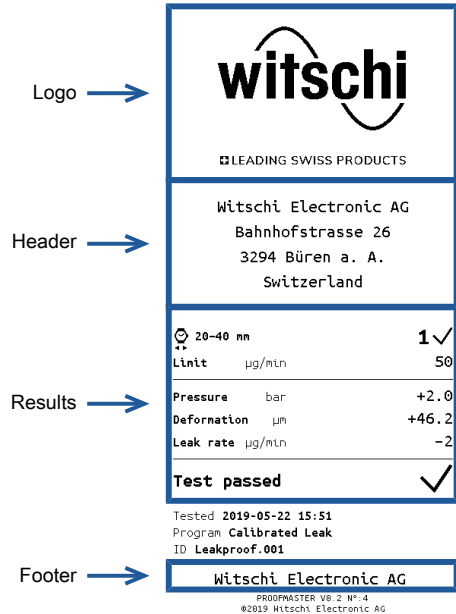

The figure above shows the different configurable areas of the label.

✓ **Printer configured.**

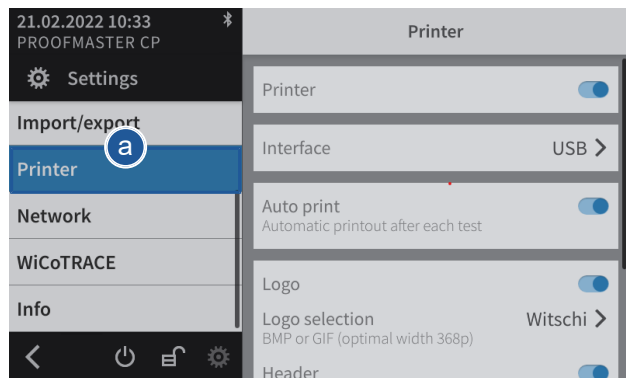

- a) Select **Printer** from the list.
 - ⇒ **Printer** is highlighted in blue and the right window displays the printer options.
- b) Configure the label as required.
 - ⇒ See the details below for the settings of each option.

Printing the logo

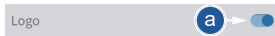

- a) Enable or disable the printing of the logo.
 - ⇒ The button is blue when the function is enabled and grey when it is not.

Selecting the logo

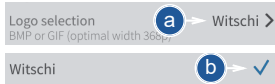

- a) Open the logo selection by tapping the name of the displayed logo.
- b) Select the desired logo from the list.
 - ⇒ In the above example, **Witschi**.
 - ⇒ The **Witschi** logo is printed on the label.

Importing the logo

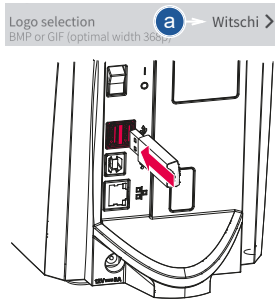

- a) Open the logo selection by tapping the name of the displayed logo.
- b) Insert a USB stick with the desired logo into the ProofMaster CP (BPM or GIF, optimal width: 368 p).



- c) Press **Load new logo**.
- d) Select the desired logo from the list.
 - ⇒ All image files (png, jpg, bmp, tec etc.) on the USB stick appear in the list.
 - ⇒ In the above example, selection of **CElogo**.
 - ⇒ The **CElogo** is now in the list and selected.
 - ⇒ The **CElogo** logo is printed on the label.

Printing the header



- a) Enable or disable the printing of the header.
 - ⇒ The button is blue when the function is enabled and grey when it is not.

Configuring the header

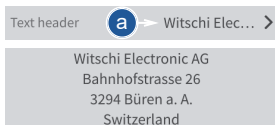

- a) Open the header configuration by tapping the beginning of the displayed header.
- b) Tap on the text area to open the alphanumeric keypad.



Selecting the results display

- c) Enter the header using the alphanumeric keypad.
 - ⇒ 4 lines with maximum 30 characters.
 - ⇒ The entered header is printed on the label.

The measurement result can be displayed in numeric or reduced form. See examples below.

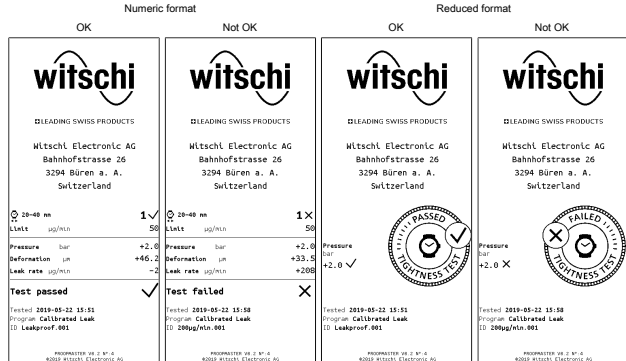

- a) Open the results display by tapping the displayed selection.
- b) Select the desired display type.
 - ⇒ In the above example, Reduced.

Printing the footer

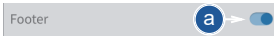

- a) Enable or disable the printing of the footer.
 - ⇒ The button is blue when the function is enabled and grey when it is not.

Configuring the footer



- a) Open the footer configuration by tapping the beginning of the displayed footer.
 - ⇒ In the following example, no text is entered in the footer.
- b) Tap on the text area to open the alphanumeric keypad.



- c) Enter the footer using the alphanumeric keypad.
 - ⇒ 4 lines with maximum 30 characters.
 - ⇒ The entered footer is printed on the label.

7.7 Network

The connection option allows automatic configuration of the ProofMaster CP with the help of a server.

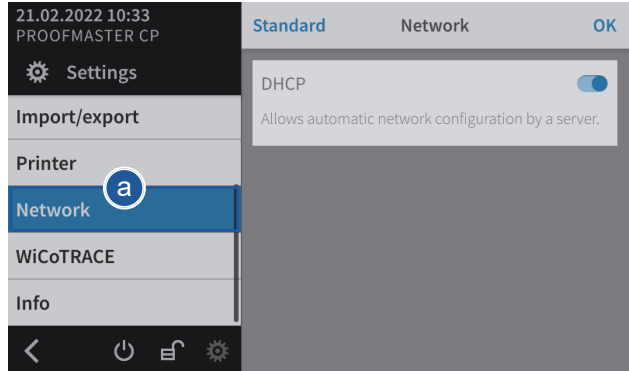

- a) Select **Network** from the list.
 - ⇒ **Network** is highlighted in blue and the right window displays the network options.
- b) Enable or disable the network.
 - ⇒ The button is blue when the function is enabled and grey when it is not.

7.8 WiCoTRACE

Possible configurations

There are two possible configurations:

- PC single user configuration. (WiCoTRACE Lite with local database);
- PC network configuration. (WiCoTRACE Server or Server+ with central database).

In both configurations, the communication is via a local Ethernet network. The ProofMaster CP should be connected accordingly in accordance with the section [Network \[Page 24 \]](#).

PC single user configuration

- ✓ **The WiCoTRACE 3 Lite software must be installed on the PC. You can find WiCoTRACE 3 Lite on the USB stick supplied.**

- a) Install the WicoTrace software on the PC.
 - ⇒ To do this, see the documentation "WiCoTRACE 3 Installationshandbuch.pdf".
- b) Connect the PC to the Ethernet network using an Ethernet cable.
- c) Read off and note down the IP address of the PC.
 - ⇒ Example: 169.254.100.100.
- d) SMX-Service must be started in the Cockpit (System/Applications). It is recommended to activate the "Start automatically" option.
 - ⇒ The Cockpit and the SMX must be started so that the ProofMaster CP can communicate with the database on the PC.

PC network configuration

The WiCoTRACE database must be installed on a server. In addition, WiCoTRACE must be installed on a PC single user station so that measuring programs can be created and the results analysed.

- a) Install the database on a server with db3 setup.exe (the "Additional services" option must be activated) and install WiCoTRACE on a PC single user station with w3isnt.exe.
 - ⇒ To do this, see the documentation "WiCoTRACE 3 Installationshandbuch.pdf".
- b) Read off and note down the IP address of the server.

ProofMaster CP

Note: The subnet mask must enable communication between the IP address of the PC or the server IP address of the ProofMaster CP.

- a) The network settings must be configured in the ProofMaster CP, see [Network \[Page 75 \]](#).
 - ⇒ Example: The ProofMaster CP uses an automatic DHCP connection.
- b) Connect the ProofMaster CP to the local network using an Ethernet cable.

The ProofMaster CP must be configured for use with the **WiCoTRACE** software.

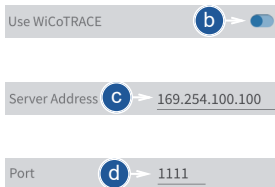
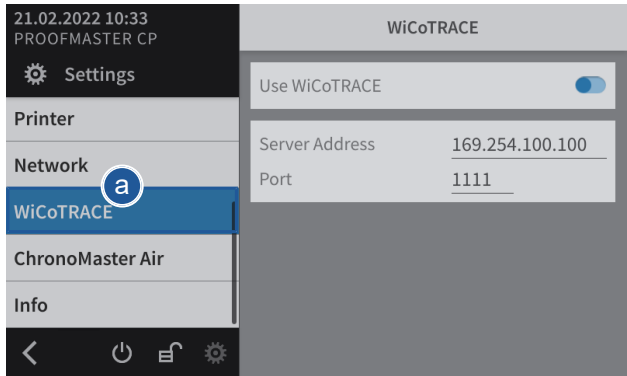

- a) Select **WiCoTRACE** from the list.
 - ⇒ **WiCoTRACE** is highlighted in blue and the right window displays the options for **WiCoTRACE**.
- b) Enable or disable the use of **WiCoTRACE**.
 - ⇒ The button is blue when the function is enabled and grey when it is not.
- c) Enter the IP address of the PC or the server where **WiCoTRACE** is located.
 - ⇒ Example: IP address: 169.254.100.100.
- d) Enter the port of the PC where **WiCoTRACE** is located.
 - ⇒ By default, the communications port set up in the **WiCoTRACE** software is "1111". This is a communications port number which is generally free in computer networks.

Use

You should consult the entire documentation for the **WicoTrace** software in order to find out about all the technical options available. When using the ProofMaster CP in a computer network, you need technical knowledge and administrator rights in order to configure the devices correctly. You must also ensure that the communications port "1111" is not blocked by a firewall. Where necessary, this port number must be adapted in the ProofMaster CP and in the SMX service of the **WicoTRACE** software.

- a) Press  to perform new measurements with the new programs.

7.9 ChronoMaster Air (establishing a connection for Bluetooth)

Initial setup

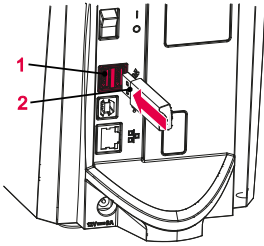

- a) Plug the USB adapter **2** into one of the two USB type **A** ports on the ProofMaster CP **1**.
 - ⇒ The Bluetooth dongle is automatically recognised by the ProofMaster CP.
 - ⇒ Switch on the ProofMaster CP and the ChronoMaster Air.

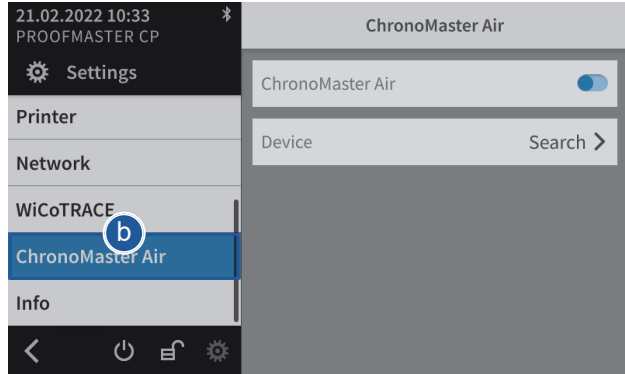

- b) Select **ChronoMaster Air** from the list.
 - ⇒ **ChronoMaster Air** is highlighted in blue and the right window displays the device options.
- c) Activate the ChronoMaster Air.
 - ⇒ The button is blue when the function is enabled and grey when it is not.
- d) Search for a device.
- e) Check the identity and selection of the device.
- f) Press **<ChronoMaste...** to save and return to the previous screen.
 - ⇒ The ChronoMaster Air is coupled.

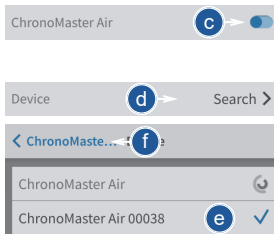

ChronoMaster Air coupled

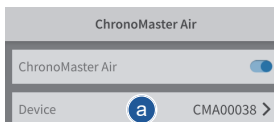

- a) Activate the ChronoMaster Air.
 - ⇒ The button is blue when the function is enabled and grey when it is not.

ChronoMaster Air not coupled

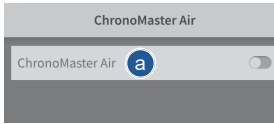

a) Deactivate the ChronoMaster Air.

⇒ The button is grey when the function is not enabled and blue when it is.

7.10 System information

This menu displays the following information:

- Serial numbers
- IP address
- Versions of the different systems and programs
- Information on device operation (cycle counter, measuring counter, etc.)
- Last calibration
- Legal information (licenses)

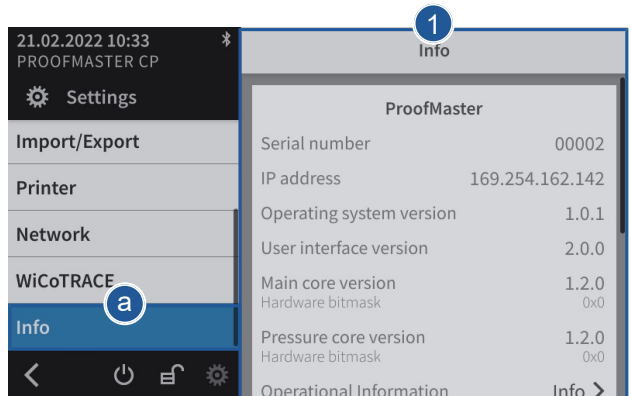

a) Select **Info** from the list.

⇒ **Info** is highlighted in blue and the right window displays the system information **1**.

Tip



Use the scroll bar on the right side of the window to display non-visible information.

8 Troubleshooting

8.1 Error messages

Info



Error messages appear when there is a malfunction on the device.

The following table contains information on the possible causes of an error message and information about troubleshooting.

The most important malfunctions are described below. Contact customer service if the error continues after taking all troubleshooting measures.

Error message	Cause	Remedy
No test specimen detected! Deformation sensor has reached lower limit. Probably no test specimen inserted.	No test specimen was inserted.	Insert test specimen.
Bell blocked! Please check whether free movement is possible.	Object jammed.	Remove object.
Catch blocked! Please check whether free movement is possible.	Object jammed.	Remove object.
Deformation sensor blocked! Please check whether free movement is possible.	Object jammed.	Remove object.
Overpressure or vacuum in test chamber! Chamber cannot be opened or closed.	Pressure could not be released from the chamber. Deformation sensor was not fitted correctly.	<i>With open bell cover:</i> Check whether the deformation sensor is fitted correctly. <i>With closed bell cover:</i> Release the pressure manually and open the bell cover (see <i>Opening the bell cover in an emergency</i> [Page 82]).
Communication error! Check whether the deformation sensor is fitted.	Deformation sensor was not fitted correctly.	Check whether the deformation sensor was fitted correctly.
Printer not found! Check the printer and USB connection.	Printer not switched on. USB cable faulty or not connected correctly.	Check the printer and USB cable.
WiCoTRACE (SMX-Service) error! Unable to connect to the SMX-Service.	Ethernet cable faulty or not connected correctly.	Check Ethernet cable.
	WiCoTRACE configuration not set correctly.	Check whether the SMX-Service of WiCoTRACE was started correctly.
		Check WiCoTRACE configuration.

Error message	Cause	Remedy
WiCoTRACE (SMX-Service) error! No reply received from the SMX-Service.	Ethernet cable faulty or not connected correctly.	Check Ethernet cable.
	WiCoTRACE configuration not set correctly.	Check whether the SMX-Service of WiCoTRACE was started correctly. Check WiCoTRACE configuration.
Vibration detected The measuring result is unreliable. Continue measuring?	A vibration was detected during the test.	Place the test device in a suitable, vibration-free location.
	Vibrations can falsify the measuring result.	

8.2 Malfunctions

Description of malfunction	Cause	Solution
Incorrect test result	The watch is not positioned correctly.	Reposition the watch. See <i>Positioning the watch</i> [Page 38].
	Adhesive or protective foil on the watch case.	Remove the adhesive or protective foil.
	The watch is not at ambient temperature.	Wait until the watch has warmed up or cooled down. Repeat the test.
	More and more incorrect test results occur. The device is not properly calibrated.	Have the device calibrated by customer service. See <i>Technical support</i> [Page 7].
Test results are not being printed	There is no more paper in the printer.	Insert a new paper roll. Please refer to the manufacturer's documentation for more information.
	Automatic printing of test results is not enabled.	Enable automatic printing of test results. See <i>Configuring the printer</i> [Page 71].

8.3 Opening the bell cover in an emergency

The bell cover can be opened manually in the following cases:

- The test was cancelled. The watch has to be removed from the test chamber.
- The test chamber does not open automatically, for example after a power failure.

Mandatory



Wear safety goggles during the entire bell cover opening process!

- Switch off the compressor as specified in the manufacturer's documentation.
- Release the air from the compressed air hose of the compressor.
- Switch off the ProofMaster CP.
 - ⇒ The remaining pressure in the test chamber escapes.
 - ⇒ See *Switching off the device* [▶ Page 34].
- If the residual pressure does not escape from the test chamber, carefully insert a thin, rounded object between the bell cover **1** and the bottom **2**.

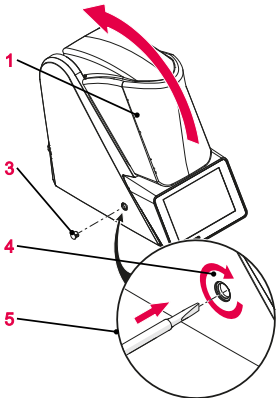
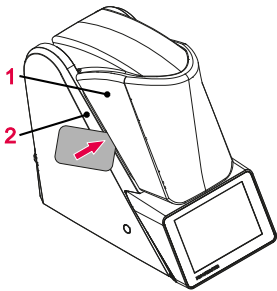

Prohibition



Do not use a pointed object to open the bell cover!

Pointed objects can lead to material damage (seal) or scratches.

- Use objects with rounded corners, e.g. playing cards.

⇒ The pressure is released.

- Wait until the pressure has completely dissipated.
- Remove the cap **3**.
- Insert a size 4 or 5 screwdriver into hole **4** and turn clockwise to release the bell cover **1**.
- Open the bell cover **1**.

9 Decommissioning and disposal

Decommissioning

Prohibition



Never force the device cover to open when the device is under pressure!

Otherwise parts could be ejected.

- ✓ **The ProofMaster CP is switched off.**
 - a) Switch off the other used accessories properly.
 - b) Pull out all cables (USB/Ethernet).
 - c) Disconnect the power supply unit connection from the local mains network.
 - d) Disconnect the power supply unit connection from the power supply connection of the ProofMaster CP.
 - ⇒ The ProofMaster CP is non-operational.

Disposal

If no return or disposal agreement has been made, return the device to a recycling point.

Caution - environmental



Improper disposal poses an environmental hazard!

Improper disposal can result in environmental pollution.

- Always contact a specially approved body for disposal of the device.
- If there is any uncertainty, contact the local government or a company specialising in waste management to find out about the conditions for environmentally sound disposal.

Electrical and electronic components



Electrical and electronic components must not be disposed of with household waste, but must be disposed of at a recycling centre or a specialised company.

10 Data sheet

Dimensions and weight

Term	Value	Unit
Weight	6.3	kg
Width	149	mm
Height with closed bell cover	243	mm
Height with open bell cover	370	mm
Depth	305	mm

Technical data

Term	Value	Unit
Vacuum range	-0.1 to -0.5 *	bar
Pressure range	0.1 to 5	bar
Accuracy of the test pressure	± 80	mbar

* maximum vacuum that can be generated depends on the atmospheric pressure.

Connection values for power supply

Term	Value	Unit
Mains voltage	100 to 240	VAC
Mains frequency	50 / 60	Hz

Power supply unit output values

Term	Value	Unit
Voltage	12	VDC
Maximum current consumption	5.0	A
Maximum power consumption	60	W
Standby power consumption	typically 2.8	W

Measuring characteristics

Term	Value	Unit
Measuring time	AUTO (20 to 300)	s
Leak-tightness limit (unit selectable: µg/min, mm ³ /min, µl/min)	as per preset programs	µg/min
Measuring resolution	0.01	µm
Deformation: Resolution 0.01 µm	-500 to 1200	µm

Ambient conditions

Term	Value	Unit
Temperature	15 to 35	°C
Relative humidity (non-condensing)	max. 80	%

Emissions

Term	Value	Unit
Noise emissions	< 75	dB(A)
Noise emissions for "Quiet pressure release" See Quiet pressure release [Page 64].	< 68	dB(A)

Notes

Notes

CE/UKCA Declaration of conformity

Dichiarazione di conformità CE/UKCA

Declaración de conformidad CE/UKCA



We **Witschi Electronic AG**
La / Nosotros: **Bahnhofstrasse 26**
CH-3294 Büren a.A.
Switzerland / Svizzera / Suiza

declare under our sole responsibility that the product

dichiara sotto la sua esclusiva responsabilità che il prodotto

declaramos por responsabilidad propia, que el producto

Name **ProofMaster CP**
nome / denominación:

Typ-Nr. **31.2510**
N. tipo / N° de tipo:

Serial-Nr. **1 – 5000**
N. di serie / N° de fabricación

Function **Tightness tester for watches**
funzione / función: **Tester di perdite per orologi / Comprobador de fugas para relojes**

doc. management **Witschi Electronic AG, Roman Siegfried, Bahnhofstr. 26, CH-3294 Büren a.A.**
Gestione doc./ Administración de documentos

Quality mgt, systems **SQS, ISO 9001:2015, Reg. Nr. 12228**
QMS certificate / Sistema de gestión de calidad

to which this declaration applies, is in conformity with the following EC-Directive(s) and standard(s) or other normative document(s):

a cui si riferisce la presente dichiarazione è conforme ai requisiti previsti dalle direttive CE ed alle norme o ai documenti normativi elencati qui di seguito:

al cual hace referencia esta declaración, satisface las disposiciones de la(s) siguiente(s) directiva(s) UE y norma(s) o documento(s) normativo(s):

Guidelines

2014/30/EG

Electromagnetic compatibility

2006/42/EG

EX machinery directive

2011/65/EU

RoHS Directive

Generic Standards

EN 61000-6-3: 2007

Electromagnetic compatibility (EMC), Emission standard for residential, commercial and light-industrial environments

+A1:2011+AC:2012

EN 61000-6-2: 2019

Electromagnetic compatibility (EMC), Immunity for industrial environments

EN ISO 12100-2010

Safety of machinery

Büren a.A., den 21. 4. 2023

Daniel Hug
Leiter Entwicklung

Roman Siegfried
Leiter Produktions-Management



☞ LEADING SWISS PRODUCTS



Witschi Electronic AG
Bahnhofstrasse 26
3294 Büren an der Aare
Switzerland
+41 32 352 05 00
www.witschi.com